



USER MANUAL



Hydra Cubus

SMART EV CHARGE POINT

Contents

- 1. Revision Records 1
- 2. Introduction..... 2
- 3. Warranty 4
- 4. Instructions for use 5
- 5. Technical parameters 7
- 6. Installation..... 10
- 7. Introduction to operation areas 25
- 8. Introduction to mobile APP 27
- 9. OCPP Connection 55
- 10. Charging Operation 59
- 11. Power management (with external smart meter or CT) 62
- 12. Load Balancing..... 63
- 13. Upgrade of the system..... 77
- 14, SIM Card Configuration..... 81
- 15, Troubleshooting 83

1. Revision Records

Rev.	Date	Modified content	Proposed by
V1.0	2023/06	Filing for the first time	R&D Department

2. Introduction

This manual introduces the H-Series European Standard AC chargers and related products, and gives the detailed description of the installation and use process.

Safety warning:

Please read this manual carefully before installing and using the charger.

Safety warning:

All installations must be operated by professionals.

2.1. General

2.1.1 About this manual

- This manual must be provided to all personnel responsible for the installation and use of the charger;
- The installation and commissioning of the charger must be operated by professionals or other qualified personnel undergoing training, and the laws and regulations related to safety must be strictly observed;
- The manufacturer of the charger is not responsible for all damage caused by violation of regulations or failure to operate according to the requirements of this manual;
- Due to product iteration, the charger manufacturer has the right to upgrade the product when necessary;
- All rights reserved. This manual shall not be copied without the written authorization of manufacturer.

2.1.2 About safety

This product adopts the most advanced technology and complies with safety and health regulations.

In case of violation of regulations or failure to follow the requirements of this manual, there may be the following risks:

- Cause harm to the life or body of users or third parties;
- Cause harm to product and other major assets of operators;
- The product is damaged and there is a risk that it cannot be used.

Please strictly follow the following guidelines when operating:

- Before any maintenance operation on the charger, the input power supply must be disconnected;
- Please use appropriate tools and take special measures to ensure that the input power supply has no voltage;
- Before the charger is connected to the power supply, please ensure that the ground wire is connected reliably;

- Power input cables, sockets and all accessories required for installation must meet the current laws and regulations;
- Please install short-circuit protection device at the power supply input end of the charger;
- Cable adapter, conversion terminal or power cord extension line shall not be used for the power cord of the charger;
- Before charging, the electric vehicle and the charger shall be reliably connected through the charging cable;
- It is strictly forbidden to move, modify or connect the charger without using protection devices, safety or monitoring equipment;
- It is strictly forbidden to reconfigure or modify product;
- Product can only run under permitted conditions.

2.1.3 About maintenance

- Do not open the charger;
- Do not touch circuit boards and electronic components;
- If the charger is damaged, do not install and use it;
- The charger can only be repaired by professionals;
- The charger can be cleaned with neutral cleaner (cleaner suitable for plastic parts).

3. Warranty

The warranty period of the charger shall be stipulated by the official sales of manufacturer.

Prerequisites for coverage of product warranty:

Follow the instructions in the manual to ensure that the product will have no fault and will be safe for use.

The following conditions are not covered by the warranty:

- Failure to comply with the installation requirements and use conditions of the charger;
- Operation and installation without the permission of the manufacturer;
- The capacity of components is not in accordance with the capacity specified by the manufacturer;
- Neglect correct operation flows, carry out incorrect operation, etc.;
- Defects caused by materials provided by the user itself;
- Improper use;
- Incorrect modification and repair;
- Disasters, impact of foreign body and force majeure, etc.

The manufacturer is not responsible for damage caused by third party's actions, including atmospheric discharge, overvoltage and chemical effects.

The warranty does not cover the replacement of wearing parts.

4. Instructions for use

The charger is an electrical equipment for charging the energy storage battery of battery electric vehicles (BEV).

Charging plugs and sockets meet the requirements of IEC 62196 (AC charging, mode 3).

The charger is suitable for indoor and outdoor use.

If the product is faulty or damaged, please contact the technician and inform the manufacturer.



The charger must be installed on the wall or matched pedestal, and the installation must be reliable and stable. It is not allowed to operate the charger in a loose state (not installed reliably), which does not meet the use requirements.



Do not disassemble, tamper with or deactivate the safety device.



No technical changes shall be made to the product without the permission of the manufacturer! In addition, if the operation is illegal, no warranty and claim are allowed.



The product can only be operated under the conditions specified in the manual.



Product installation and use, must be conducted by professional or trained personnel in accordance with the installation and use requirements.



The users must:

Read and understand this manual;

All safety instructions have been read and understood.



The professionals (Electrical Engineer/Technical Specialist), are only allowed to carry out installation, initial operation, inspection and configuration, and the professionals must have read and understood this manual.

5. Technical parameters

Product information				
Picture				
Model	HC-7-T-BLK	HC-7-SO-BLK	HC-11-T-BLK HC-22-T-BLK	HC-11-SO-BLK HC-22-SO-BLK
Power	1.4-7.4kW	1.4-7.4kW	3.5-11kW(HC-11-T-BLK) 3.5-22kW(HC-22-T-BLK)	3.5-11kW(HC-11-SO-BLK) 3.5-22kW(HC-22-SO-BLK)
Charging mode	MODE 3 CASE C (Tethered version)	MODE 3 CASE B (Socket version)	MODE 3 CASE C (Tethered version)	MODE 3 CASE B (Socket version)
Standard of charging cable	Type 2	--	Type 2	--
Standard of charging socket	--	Type 2	--	Type 2
Dimensions (width × height × depth)	260×260×100 mm	260×260×110 mm	260×260×100 mm	260×260×110 mm
Weight	4kg	2.5kg	4kg (HC-11-T-BLK) 5kg(HC-22-T-BLK)	2.5kg (HC-11-SO-BLK) 2.7kg(HC-22-SO-BLK)
Material of shell	PC+ASA (UL94-V0)	PC+ASA (UL94-V0)	PC+ASA (UL94-V0)	PC+ASA (UL94-V0)
Heat dissipation	Natural cooling	Natural cooling	Natural cooling	Natural cooling
Installation	Wall-mounted /pedestal	Wall-mounted /pedestal	Wall-mounted /pedestal	Wall-mounted /pedestal
Electrical parameters				
Rated voltage	230 V±15%	230 V±15%	400V±15% (three-phase) 230V ±15% (single-phase)	400V±15% (three-phase) 230 V±15% (single-phase)
Frequency	50/60Hz±10%	50/60Hz±10%	50/60Hz±10%	50/60Hz±10%

Grid system	TN/TT/IT(1P+N+PE or 2P+PE)	TN/TT/IT(1P+N+PE or 2P+PE)	TN/TT (3P+N+PE) (three-phase) TN/TT/IT(1P+N+PE or 2P+PE) (single-phase)	TN/TT(3P+N+PE) (three-phase) TN/TT/IT(1P+N+PE or 2P+PE) (single-phase)
Efficiency	>99%	>99%	>99%	>99%
Electric leakage protection	DC leakage (6mA)	DC leakage (6mA)	DC leakage (6mA)	DC leakage (6mA)
Charging start methods	APP start RFID card start OCPP start	APP start RFID card start OCPP start	APP start RFID card start OCPP start	APP start RFID card start OCPP start
Status display	LED strip display (red/green/blue) APP display	LED strip display (red/green/blue) APP display	LED strip display (red/green/blue) APP display	LED strip display (red/green/blue) APP display
Electric energy metering	Metering chip ($\pm 1\%$)	Metering chip ($\pm 1\%$)	Metering chip ($\pm 1\%$)	Metering chip ($\pm 1\%$)
Communication	WiFi Ethernet 4G Bluetooth RS485	WiFi Ethernet 4G Bluetooth RS485	WiFi Ethernet 4G Bluetooth RS485	WiFi Ethernet 4G Bluetooth RS485
OCPP	OCPP1.6J	OCPP1.6J	OCPP1.6J	OCPP1.6J
Upgrade	Local APP upgrade Remote OCPP upgrade	Local APP upgrade Remote OCPP upgrade	Local APP upgrade Remote OCPP upgrade	Local APP upgrade Remote OCPP upgrade
Records	Charging record Fault record	Charging record Fault record	Charging record Fault record	Charging record Fault record

Protection function	Overcurrent protection (external MCB) Overvoltage protection Undervoltage protection Relay overtemperature protection Over-temperature protection of charging plug base Over-temperature protection of incoming terminal CP protection Relay adhesion protection Electric leakage protection Ground protection	Overcurrent protection (external MCB) Overvoltage protection Undervoltage protection Relay overtemperature protection Over-temperature protection of charging plug base Over-temperature protection of incoming terminal CP protection Relay adhesion protection Electric leakage protection Ground protection	Overcurrent protection (external MCB) Overvoltage protection Undervoltage protection Relay overtemperature protection Over-temperature protection of charging plug base Over-temperature protection of incoming terminal CP protection Relay adhesion protection Open-phase protection Electric leakage protection Ground protection	Overcurrent protection (external MCB) Overvoltage protection Undervoltage protection Relay overtemperature protection Over-temperature protection of charging plug base Over-temperature protection of incoming terminal CP protection Relay adhesion protection Open-phase protection Electric leakage protection Ground protection
Protection grade	IP65	IP55	IP65	IP55
Ambient temperature	-25°C ~ +50°C	-25°C ~ +50°C	-25°C ~ +50°C	-25°C ~ +50°C
Humidity	≤95%RH	≤95%RH	≤95%RH	≤95%RH
Certification				
Standards	IEC 61851-1: 2017 (RED WiFi 2.4GHz----RF: EN 300 328 RF-EMC: EN 301 489-1&-17 Health (MPE): EN 62311) (RED RFID 13.56MHz----RF: EN 300 330 RF-EMC: EN 301 489-1&-3 Health (MPE): EN 62311)			
CE certification	CE (Rheinland)/UKCA (Rheinland)			
RoHS/REACH Certification	RoHS/REACH (Rheinland)			

6. Installation

The following content describes the installation process of the charger.



It must be carried out by professionals.

6.1 Installation conditions and environmental requirements

The charger can be used outdoors. The charger must operate in the environment required by the manual, otherwise the life of the charger will be affected. The installation and operation of the charger must meet the following conditions:

- The ambient temperature of use must be $-25\text{ }^{\circ}\text{C} \sim 50\text{ }^{\circ}\text{C}$;
- Humidity $\leq 95\%$ RH;
- The installation position shall not have strong vibration or mechanical impact;
- The charger must be kept away from explosives or dangerous goods, conductive medium and harmful gas;
- The charger must be clean, free from mildew, away from wet dust, flammable and explosive gas and liquid, away from heat sources and corrosive environment;
- The installation altitude of the charger is ≤ 2000 meters.

6.2 Accessories for installation

The following accessories are required for the charger installation:

- User manual (1 copy, see the charger accessory bag);
- Expansion screws (4 sets for CASE B version and 7 sets for CASE C version, see the charger accessory bag), which are used to fix the charger on the wall and the charging cable hanging device;
- Positioning cardboard (1 piece, in the charger packing box) for positioning the wall surface mounting hole;
- Back pegboard (1 piece, fixed on the back of the charger already), it need to be disassembled from the charger to fix it on the wall/pedestal when the official installation starts;
- Charging cable hanging device (1 piece, in the charger packing box), used for CASE C to wind charging cable.

6.3 Install short-circuit protection device

There is overcurrent protection detection assembly inside the charger. However, a short circuit protection device must be installed at the front end of the charger power supply incoming line, for example, an air switch must be installed at the front end of the charger power supply incoming line.

Do not use the charger if short circuit protection device is not installed.

The rated current of short circuit protection device is about 1.2 times of the maximum current of the charger.

If the charger is running at full load, it is recommended that the rated current of short circuit protection device shall be 40A.



Class B or Class C air switch must be installed at the front end of the charger power supply incoming line. If you have any questions about the selection of air switch, you can contact the manufacturer directly.

6.4 Install residual current protection device

According to IEC61851-1 standard, the charger must include electric leakage protection function. When DC electric leakage (DC leakage signal ≥ 6 mA) occurs during charging, power supply for charging will be disconnected.

An external type A RCCB , with supply disconnection in case of fault current above 30mA Shall be installed in the upstream side.



The selection and installation of electric leakage detection device must be carried out by professionals.

6.5 Overvoltage protection

The overvoltage level of the charger meets Class III overvoltage protection.

6.6 Power incoming line Installation

The cross-sectional area of the power supply incoming line connected to the charger must be in the range of 6-10 mm².



Power incoming line must be selected by professional installers, please refer to national safety regulations and the latest electrical installation technology!

6.7 Power supply system

Both of single-phase or three-phase chargers support the following power supply systems:

- TN-S;
- TN-C;
- TN-C-S;
- TT;
- IT (only support single-phase charger)

For single-phase charger, in the power supply system with neutral line, the voltage between phase line and neutral line cannot be higher than the rated voltage (240VAC); in a power supply system without neutral wire, the voltage between phase lines cannot be higher than the rated voltage (240VAC).



For the three-phase charger, in the power supply system with neutral line, the voltage between the phase line and the neutral line shall not be higher than the rated voltage (240VAC).

6.8 Wall Mounting

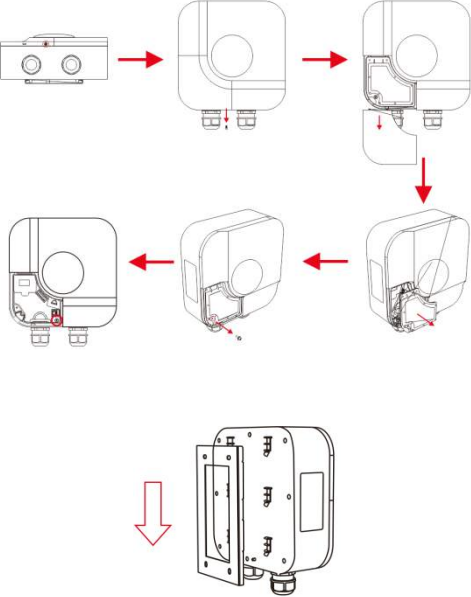
The following are the steps for installing the charger on the wall (taking CASE C as an example):

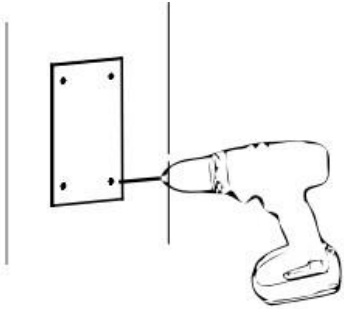
No.	Description	Picture
1	<p>The charger and its accessories are as follows:</p> <ul style="list-style-type: none"> • Charger (1 piece); • Manual (1 piece); • Expansion screws (7 sets); • Positioning cardboard (1 piece); • Back pegboard (1); 	
2	<p>Remove back bracket: Remove one screw fixing the exterior trim cover plate and remove the exterior trim cover; Remove one screw fixing the sealing cover and remove the sealing cover; Remove a screw fixing the back bracket, slide the back bracket down to remove it from the back of the whole machine;</p>	

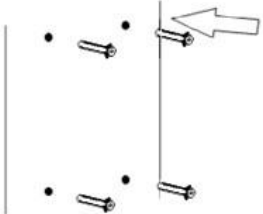
<p>3</p>	<p>Tools to be prepared:</p> <ul style="list-style-type: none"> • Percussion drill; • ϕ 6*150mm percussive bit; 	
<p>4</p>	<p>Punch holes for wall mounting:</p> <p>The positioning cardboard is attached closely to the wall, and the recommended height is: the distance from the center of the positioning cardboard to the ground is 1300mm;</p> <p>Check whether the positioning cardboard is horizontally aligned with the wall surface;</p> <p>Whole charger: Through the four holes on the whole charger positioning cardboard, mark the punching position on the wall surface;</p> <p>Charging cable holder: Through the three holes on the charging cable holder positioning cardboard, mark the punching position on the wall surface.</p>	

<p>5</p>	<p>Install expansion tubes: Whole charger: insert four expansion tubes into four wall surface mounting holes and press them into place by hand. If they are not in place after pressing by hand, please use tools (hammers, etc.) to make the expansion pipes into place; Charging cable holder: insert two expansion tubes into two wall surface mounting holes and press them into place by hand. If they are not in place after pressing by hand, please use tools (hammers, etc.) to make the expansion tubes into place.</p>	
<p>6</p>	<p>Fix the back bracket: Fix the back bracket: Fix the back bracket on the wall with 4 expansion screws, fix it reliably.</p>	

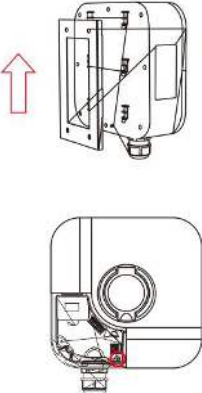
7	<p>Fix the charger:</p> <p>Slide the charger down from top to bottom, fix it on the back bracket;</p> <p>Install 1 screw for fixing the back back bracket.</p>	
8	<p>Fix the charging cable holder:</p> <p>When fixing the charging cable holder on the wall, use 3 expansion screws for reliable fixation.</p>	

<p>Power wiring:</p> <p>Remove the power protection cover;</p> <p>Measure the length of the power cord, strip the power cord, and conduct crimping between the top end of the stripped cable and the tube-shaped terminal, if it is 6mm² cable, it is recommended to use a 6012 tube-shaped terminal;</p> <p>Remove the waterproof gland and fastening ring, and the power cord passes through the waterproof gland and fastening ring;</p> <p>Connect the power cord according to the marks on the sealing cover;</p> <p>9 Install the power supply protection cover;</p> <p>Install the sealing cover, and fix it reliably with one screw;</p> <p>Install the exterior trim cover, and fix it reliably with one screw;</p> <p>Installation of the charger is completed!</p>	
--	--

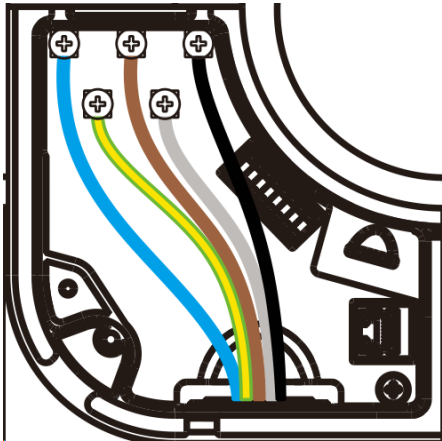
<p>10</p>	<p></p> <p>Ensure that the power supply incoming line is not connected to the power supply.</p> <p>It should be noted that the power supply incoming line must be fixed tightly with waterproof gland to avoid pulling by external force;</p> <p>Definition of supply power incoming lines (from left to right):</p> <p>N: Blue PE: Yellow-green L1: Brown L3: Grey L2: Black</p>	
------------------	--	---

6.9 Charger Installation on pedestal

If the customer decides not to install the charger on the wall, while install it on the pedestal (it shall be a special pedestal provided by the supplier), please follow the following steps. Please note that when installing on pedestal, the installer needs to provide matching screws and other accessories according to different installation sites (take CASE C as an example).

No.	Description	Picture
-----	-------------	---------

1

Install the pedestal on a stable and solid concrete platform. If there is no suitable installation platform, you can pour a special installation platform. The installation platform must be equipped with M8 expansion bolts and PVC conduit with a diameter of 40mm (wiring for power supply inlet) which should be embedded under the base.

The installation platform must be level, stable and safe, avoid unreliable installation of pedestal!

If it is a newly poured concrete installation platform, please continue the installation after the concrete has solidified.

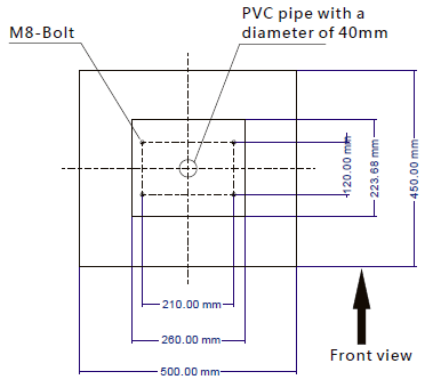

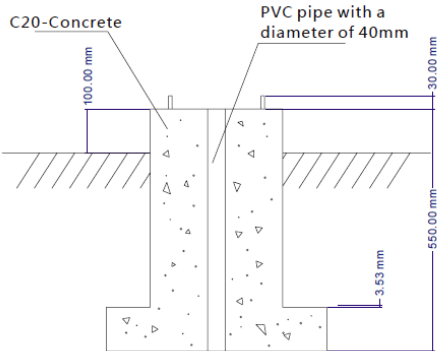
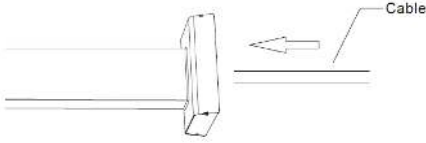
<p>2</p>	<p>The depth of M8 expansion bolts embedding into the installation platform should not be less than 80mm, and the exposed length of expansion bolts is recommended to be 15 ~ 30mm.</p> <p>The length of the power supply incoming line passing through the PVC conduit on the ground cannot be less than 1300mm, so that make it convenient for installing the power supply incoming line.</p>	 <p>The diagram shows a cross-section of a pedestal base. It features a concrete base labeled 'C20-Concrete' with a height of 100.00 mm. A PVC pipe with a diameter of 40mm is embedded in the concrete. The total height of the pedestal is 550.00 mm. The exposed length of the PVC pipe is 30.00 mm. A dimension of 3.53 mm is also indicated at the bottom of the pipe.</p>
<p>3</p>	<p>Tilt the pedestal and make power supply incoming line pass through the bottom until the incoming line is seen at the cable outlet in the middle of the pedestal.</p>	 <p>The diagram shows a tilted pedestal with a cable passing through it. The cable is labeled 'Cable' and is shown entering from the right and exiting from the left. An arrow points to the cable, indicating its direction of travel.</p>

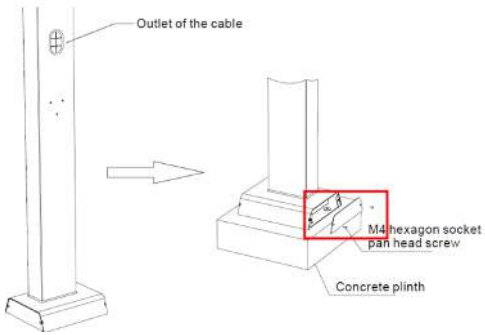
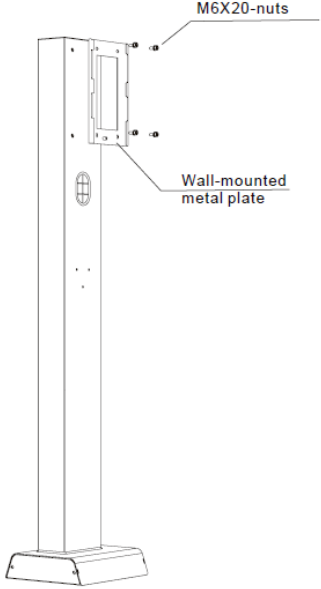
<p>4</p>	<p>Pull out the power supply incoming line from the cable outlet in the middle of the pedestal, remove the left and right side plates of the pedestal base (red column in the right figure), then vertically pass through M8 expansion bolts on the installation platform, and fix the pedestal with M8 screws and flat pad (column accessories include 4 $\phi 8$ flat pads). Finally, install the left and right side plates of the pedestal base.</p>	
<p>5</p>	<p>Remove the back bracket on the back of the charger; Continue to remove the four $M6 \times 20$ screws of the pedestal suspension plate; Align the back bracket with the four screw holes of the pedestal hanging plate, and fix the back pegboard on the pedestal with four $M6 \times 20$ screws.</p>	

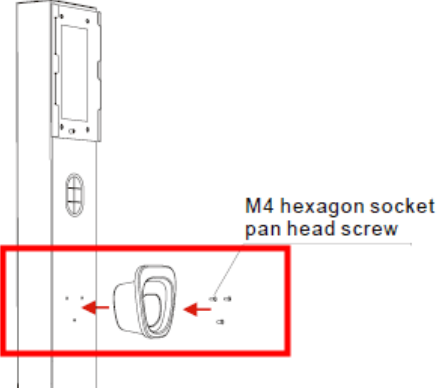
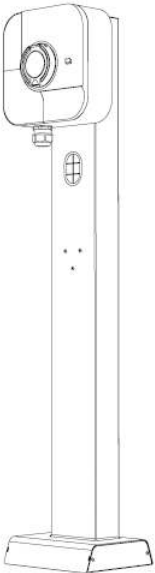
<p>6</p>	<p>Fix the charging plug line hanging device:</p> <p>Fix the charging plug line hanging device on the pedestal (red column) with three M4 × 8 screws, and fix it reliably.</p>	 <p>M4 hexagon socket pan head screw</p>
<p>7</p>	<p>Install the charger on the back bracket (slide the charger down from top to bottom and insert the back pegboard completely), and fix the charger and the back bracket with screws to ensure reliable installation of the charger.</p> <p>Up to 2 pieces charger can be installed on one pedestal.</p>	

<p>Wiring of power cord:</p> <p>Remove the power supply protection cover;</p> <p>Measure the length of the power cord, strip the power cord, and conduct crimping between the top end of the stripped cable and the tube-shaped terminal, if it is 6mm² cable, it is recommended to use a 6012 tube-shaped terminal;</p> <p>Remove the waterproof gland and fastening ring, and the power cord passes through the waterproof gland and fastening ring;</p> <p>8 Connect the power cord according to the marks on the sealing cover;</p> <p>Install the power supply protection cover;</p> <p>Install the sealing cover, and fix it reliably with one screw;</p> <p>Install the exterior trim cover, and fix it reliably with one screw;</p> <p>The installation of the charger is completed!</p>	
---	--



Ensure that the power supply incoming line is not connected to the power supply!

It should be noted that the power supply incoming line must be fixed tightly with waterproof gland to avoid pulling by external force;

Definition of supply power incoming lines (from left to right):

N: Blue

PE: Yellow-green

L1: Brown

L3: Grey

L2: Black

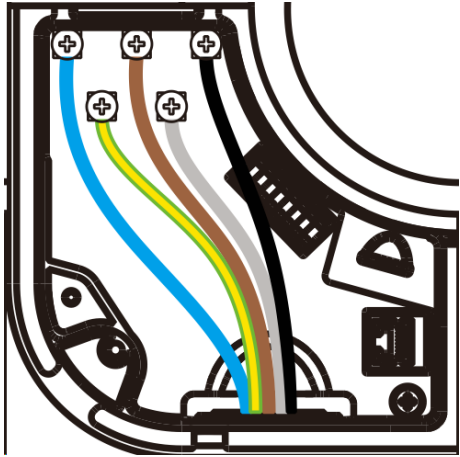

7. Introduction to operation areas

After installation of the charger is completed, the electric vehicle can be charged. The operation area and display of the charger are described below.

7.1 Display Panel

There are display areas on the front of the charger: AREA 1 and AREA 2.



The display functions of each areas are as follows:

Display	Type	Description of functions
AREA 1	RFID card swiping area	<ul style="list-style-type: none">Used for swiping RFID card, starting and stopping charging.
AREA 2	LED indicator	<ul style="list-style-type: none">LED indicator ring displays the charger status with different colors.

7.2 Card swiping area (AREA 1)

This area is RFID card working area, RFID card is used to start and stop charging. To perform RFID card swiping, the user needs to place the RFID card within the scope of the card statistics device.

7.2 LED indicator (AREA 2)

LED indicator ring		
Color	Flashing mode	Status
White	flash	A7-M3 communication failure M3 starts first after power on When A7 is not started successfully A7 Upgrade
White	Not flash	M3 Upgrade
Green	Slowly flash	Standby mode, the charger completes the self-inspection;
Green	Not flash	Connected Platform
Blue	Fast flash	Insert the charging plug or stop charging
Blue	Slowly flash	Charging mode, the charger is conducting the charging;
Blue	Not flash	End charging
Red	/	Detection and alarm for internal protection of the charger

8. Introduction to mobile APP

The charger has five communication interfaces for connection to the outside:

- WiFi interface: used to connect OCPP platform;
- Ethernet interface: used to connect OCPP platform, or to realize the networking among multiple chargers through switchboard;
- 4G interface: used to connect OCPP platform;
- Bluetooth interface: used to connect mobile APP;
- RS485 bus interface: Used to connect external electricity meter or CT, realize load balancing function;

8.1 Overview of the APP

Hcharger APP is a user APP developed by manufacturer, it is used with the charger. It interacts with the charger by Bluetooth communication. With the human-machine interaction interface, it can remotely control the operation of the charger and monitor the charger parameters without contact.

APP has good usability and reliability, and ensures the security and reliability of information.

8.2 Running environment

The APP can run on the mobile phone powered by Android 8.0 and IOS 11.0 and above.

8.3 APP installation

Android mobile phones downloads and installs the APP through major domestic application markets (Huawei application market, Xiaomi application market, OPPO application market, VIVO application market, Samsung application market, etc.).

Android overseas phones can download and install the APP through Google Play.

IOS phones can download and install the APP by searching Hcharger in the APP store.

8.4 Functions of APP

- Use BLE to interact with the charger;
- The charging function of the charger can be started/stopped;
- You can view the charger parameter information and charging parameters;
- You can view charging records and fault records;
- The charger system settings can be configured;

- The charger online mode can be configured;
- The charger operation modes can be modified;
- Load balancing function can be configured;
- RF card parameters can be configured;
- The charger can be upgraded remotely;
- You can set reservation charging function of the charger.

8.5 Detailed introduction to APP(See the last page for app download):

8.5.1 User interface

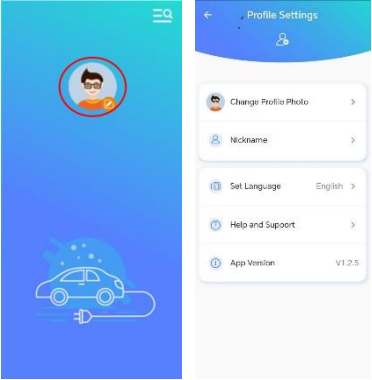
Steps	Description	Picture
1	<p>After the installation, the user clicks on the mobile APP icon to enter into the APP main interface;</p> <p>Left figure: Bluetooth is not turned on;</p> <p>Right figure: Turn on Bluetooth and enter into the main interface of APP.</p>	
2	<p>User configuration:</p> <p>Click the User Configuration button (red circle) in the main interface of the APP to enter the personalized configuration interface of the APP, and set the avatar (currently, users only can select avatar from the avatars built in the APP), nickname, gender and language (currently only Chinese and English are supported, and it will be updated gradually in the future). The operation instructions and after-sales support of APP are in the Help and Support functions.</p>	

3

Connect the charger:
Click the button (red circle) which is in the upper right corner of main interface of the APP, it will display the name of the charger within the current Bluetooth range. Select one charger and click the connect button to connect the charger, the name of the currently connected the charger will be displayed in the middle of the main interface of APP. At this time, click the name of the charger to enter the operation interface of the charger.

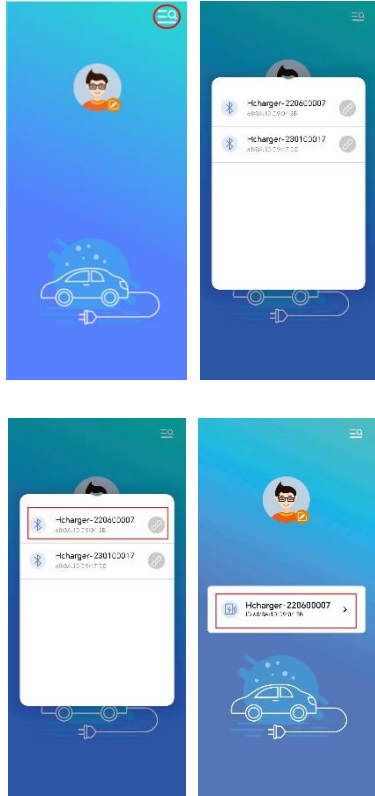

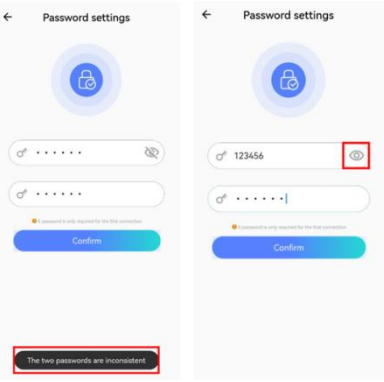
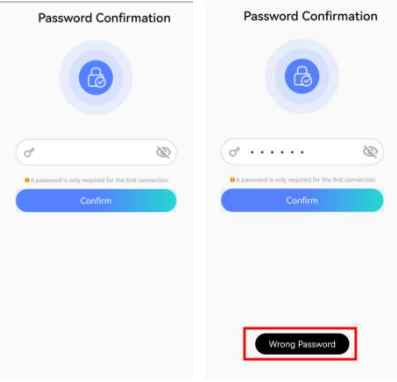
<p>4</p>	<p>Settings of password:</p> <p>When you use the APP for the first time or the charger parameters are reset, the password of the charger needs to be configured.</p> <p>When setting the password, you need to input the same password twice before it can be set successfully. The current password is limited to 6 characters including ASCII characters a-z, A-Z, 0-9. If the password settings twice are different, the user will be prompted to configure the same password twice.</p> <p>There is an eye-shaped icon (the red column in the right second figure) behind the password input column, and the password can be displayed after clicking it.</p>	
<p>5</p>	<p>When exiting the APP and logging in again, you need to input the password configured then you can enter the charger operation interface. If the password is incorrectly, it will prompt that the password is wrong (the red column in the right second figure).</p> <p>⚠️ Note: APP can only connect one charger at a time!</p>	

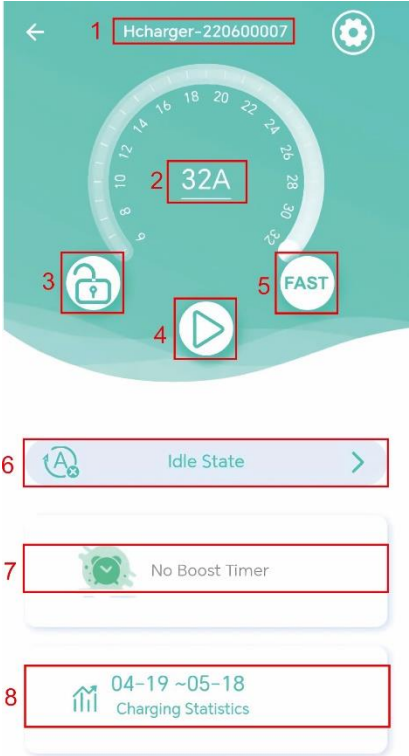

<p>6</p>	<p>Main interface of the APP: After the password is set or input successfully, it will enter into the main interface of the charger display, in which:</p> <ol style="list-style-type: none"> 1. Name of current charger; 2. Maximum charging current; 3. Locking state of electronic lock (CASE B); 4. Start-stop button of the charger; 5. Boost (acceleration) (click this button under ECO/ECO+mode, the charger will switch to FAST mode for charging, and click it again to return to the original state); 6. Charging information display (charging voltage, charging current, fault status, etc.); 7. Setting of time period of fast charging; 8. Statistics of charge. 	 <p>The screenshot shows the main interface of the Hcharger app. At the top, a back arrow is on the left and a gear icon is on the right. A red box labeled '1' highlights the header 'Hcharger-220600007'. Below this is a large circular gauge with numbers 0 to 32. A red box labeled '2' highlights the number '32A' on the gauge. At the bottom of the gauge, there are four icons: a padlock (labeled '3'), a play button (labeled '4'), and a 'FAST' button (labeled '5'). Below the gauge are three horizontal panels: 'Idle State' (labeled '6'), 'No Boost Timer' (labeled '7'), and '04-19 ~05-18 Charging Statistics' (labeled '8').</p>
----------	--	---

Status of the charger:

1. Standby;
2. The charger is plugging in
3. Charging is starting;
4. Charging is in progress;
5. Pause charging;
6. Charging is completed;
7. Failure;
8. Alarm;
9. Fault and alarm (fault and alarm statuses are displayed at the same time).

7

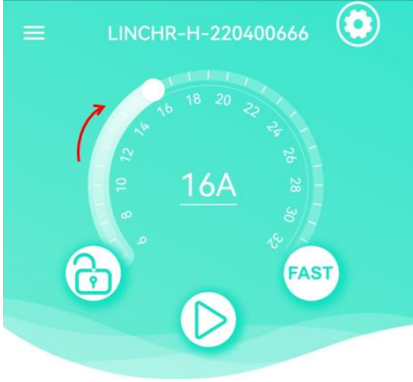

<p>Setting of maximum charging current:</p> <p>In the main interface of the charger display, the maximum charging current of the charger can be set by sliding the dial. Slide it clockwise, the current will increase and slide it counterclockwise, the current will decrease, and the adjustment accuracy is 1A.</p> <p>For example, as shown in the right figure, adjust the dial clockwise, the current increase to 24A from 16A. The maximum current of 7kW and 22kW chargers can be set to 32A, and the maximum current of 11kW charger can be set to 16A.</p>	 <p>The screenshot shows the main interface of the LINCHR-H-220400666 charger. At the top, there is a menu icon on the left and a settings gear icon on the right. The central feature is a circular dial with a scale from 0 to 32 in increments of 2. The dial is currently set to 16A. A red arrow points clockwise from the 16A mark, indicating that rotating the dial in this direction will increase the current. Below the dial, there is a play button icon. To the left of the dial is a lock icon, and to the right is a 'FAST' button.</p>
<p>Locking of the charger:</p> <p>The charger can be set to "State Locking". When the charger is locked under non-charging state, the charger cannot start charging;</p> <p>When the charger is locked during charging, the charger cannot start the next charging after finishing this charging.</p> <p>Click the Lock/Unlock button in the main interface (red circle in the right figure) to set the charger to "State Locking".</p>	 <p>The screenshot shows the same main interface as the previous one, but the dial is now set to 32A. A red circle highlights the lock icon, which is currently in the 'locked' state (the lock symbol is solid). This indicates that clicking this icon will set the charger to 'State Locking'.</p>

10

Boost timer:
Click on the "Boost timer" icon (red circle) to enter into the timing charging list.
When the timing charging of the charger is not set, the timing charging list is empty. You can click the "+" sign on the interface to add timing charging information, and set the timing charging period as "Every Day" or "Only Once", the timing start time needs to be earlier than the timing end time, and you can set up to four timing charging lists (the 2nd figure in the right).
If the time of configured timing charging list is repeated with the existing timing charging list, it will prompt that the current timing charging periods are repeated.
After completing the setting of the timing charging list, you can enable/disable any current timing charging. If the timing charging is configured as "Disable", this timing charging will not be started.

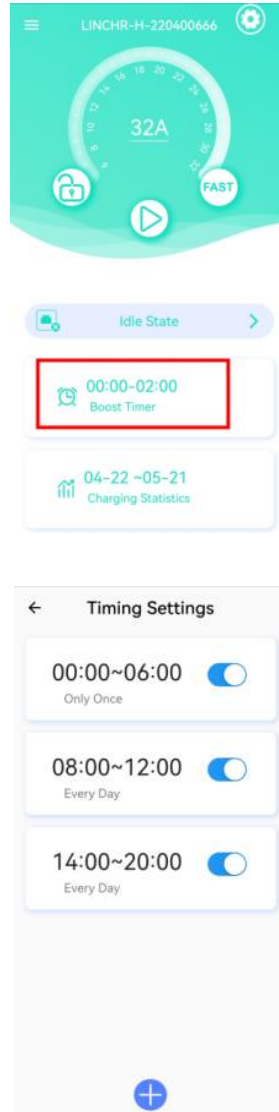

11

Statistics of charge:



Click on the charge statistics on the main interface of APP to view the charge of the charger in every day of the latest month and every month of the latest year.





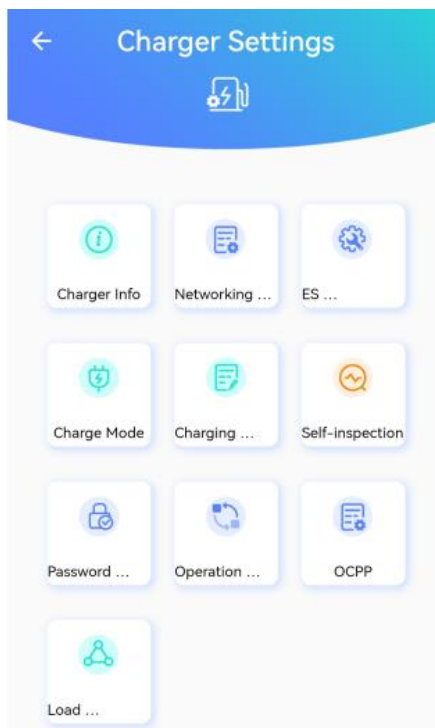

12

The setting interface of the charger:
Click the Setting button on the main interface (red circle in the right figure) to enter into the setting interface of the charger, in the interface, you can view and configure the functions of the charger. It includes the charger information viewing, the charger network configuration, electrical system configuration, charging mode configuration, charging record viewing, fault self-diagnosis, password reset, operation mode configuration, OCPP configuration and load balancing setting. Click on the configuration items to read and configure each function of the charger.

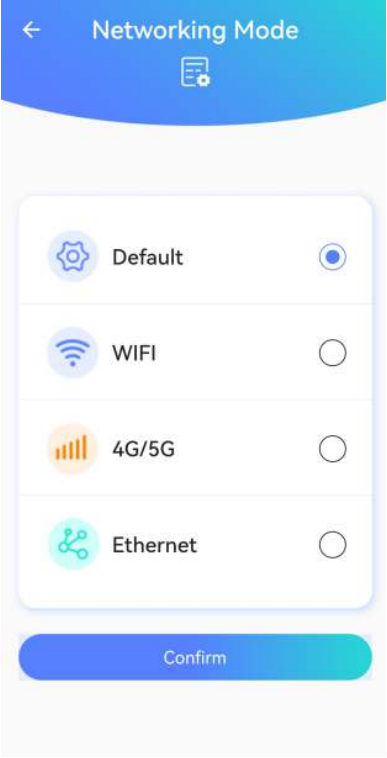

<p>13</p>	<p style="text-align: center;"></p> <p style="text-align: center;">Charger Info</p> <p>The charger information: Click the "Charger Info" button to view the information of current charger, including the charger board SN(serial number), the charger SN(serial number), software version, and the IEMI number, ICCID number and IMSI number of SIM card.</p>	 <p>The screenshot shows the 'Charger info' screen with the following data:</p> <table border="1"> <thead> <tr> <th>Field</th> <th>Value</th> </tr> </thead> <tbody> <tr> <td>Board serial number</td> <td>7122030000203101050100A01</td> </tr> <tr> <td>Charger serial number</td> <td>7122030000203101050100A01</td> </tr> <tr> <td>Software Version</td> <td>83105120000_JLS2103_V000B01D03;V000B01D02</td> </tr> <tr> <td>IEMI</td> <td>893412FX215EDGY</td> </tr> <tr> <td>ICCID</td> <td>898600MFSSYYG123456P1</td> </tr> <tr> <td>IMSI</td> <td>310150123456789</td> </tr> </tbody> </table>	Field	Value	Board serial number	7122030000203101050100A01	Charger serial number	7122030000203101050100A01	Software Version	83105120000_JLS2103_V000B01D03;V000B01D02	IEMI	893412FX215EDGY	ICCID	898600MFSSYYG123456P1	IMSI	310150123456789
Field	Value															
Board serial number	7122030000203101050100A01															
Charger serial number	7122030000203101050100A01															
Software Version	83105120000_JLS2103_V000B01D03;V000B01D02															
IEMI	893412FX215EDGY															
ICCID	898600MFSSYYG123456P1															
IMSI	310150123456789															

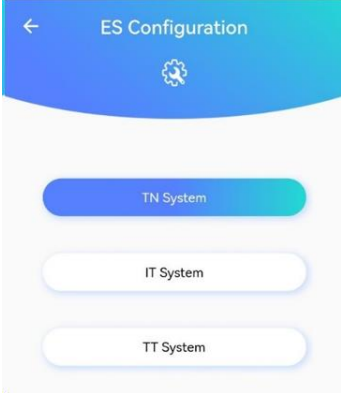
<p>14</p>	<p style="text-align: center;"></p> <p style="text-align: center;">Networking Mode</p> <p>Network configuration:</p> <p>Click the Networking Mode button to select four networking access modes: default networking, WiFi networking, 4G networking and Ethernet. The default networking sequence order is Ethernet > WiFi > 4G. When configuring the default networking mode, the WiFi user name, password, Ethernet IP, subnet mask and gateway must be configured, then the default networking mode can be used.</p> <p>If you choose WiFi for networking, you need to configure your user name and password;</p> <p>If you choose Ethernet, you need to modify IP information according to network requirements;</p> <p>If you choose 4G, you need to insert SIM card into the charger. If the network settings has change, the charger will automatically restart, and after restarting, the operation will be executed according to the network settings after modifying.</p>	
-----------	---	--

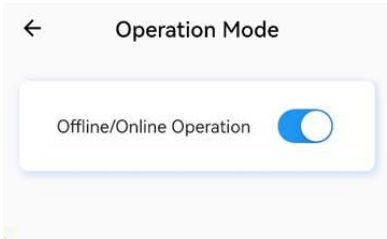
<p>15</p>	 <p>ES Configuration</p> <p>Configuration of power supply system:</p> <p>Click the ES Configuration button to configure the charger power supply system, and TN/IT/TT can be selected.</p>	
<p>16</p>	 <p>Operation Mode</p> <p>Operation mode configuration:</p> <p>Click the Operation Mode button to switch the operation mode of the charger when the charger is idle (no charging plug is inserted);</p> <p>It is divided into online mode (connecting platform for operation) and offline mode (local offline operation).</p> <p>Online mode: the charger is connected to the platform, and all charging operations are controlled by the platform;</p> <p>Offline mode: the charger is connected with APP, and all charging operations are controlled by APP.</p>	



Charging Record

Charging record inquiry:

Click the Charging Record button to view the charging record of the current charger. If it has never used for charging, the inquiry interface will be displayed as empty, otherwise the charging record will be displayed in the APP according to the current charging number and maximum charging number of the charger.

Click the Export Charging Record File button in the lower right corner of the charging record interface (red circle in the 2nd figure on the right) to export the charging record file in Excel format and it will be stored in the mobile phone.

17

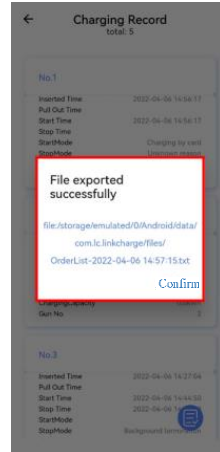
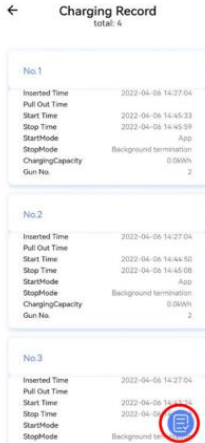

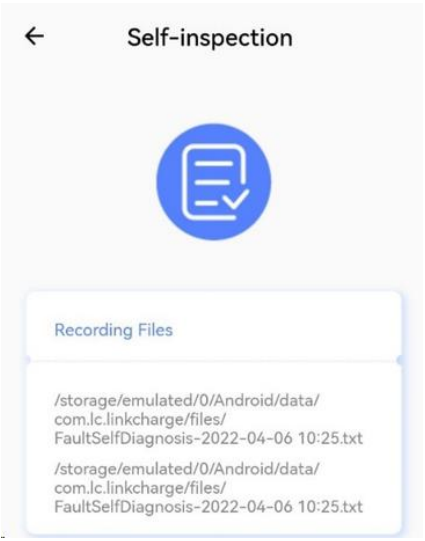
18	 <p>Self-inspection</p> <p>Fault self-inspection: Click the Self-inspection button to export a charger inspection report file and it will be stored in the mobile phone.</p> <p>The function is only used for manufacturers to analyze fault states.</p>	 <p>The screenshot shows the 'Self-inspection' screen of an application. At the top left is a back arrow, and the title 'Self-inspection' is centered. Below the title is a large blue circular icon containing a white document with a checkmark. Underneath is a section titled 'Recording Files' which contains two file paths: <code>/storage/emulated/0/Android/data/com.lc.linkcharge/files/FaultSelfDiagnosis-2022-04-06 10:25.txt</code> listed twice.</p>
----	--	---

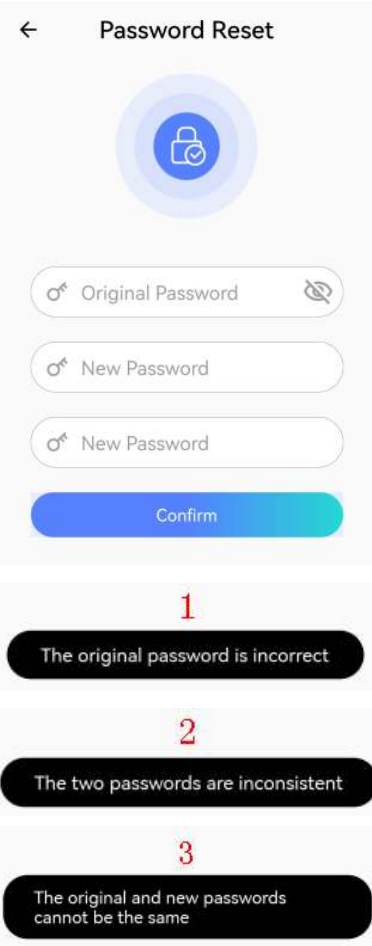
19	<p style="text-align: center;"></p> <p style="text-align: center;">Password Reset</p> <p>User password modification: Click the Password Reset button to modify the user's password.</p> <p>The prompt for password modification failure is as follows:</p> <ol style="list-style-type: none">1. If the original password is input incorrectly, it will prompt that the password setting failed;2. If the new password input twice is inconsistent, it will prompt that two new password is inconsistent;3. If the new and old passwords input are same, it will prompt that the new and old passwords are same.	 <p>The screenshot shows a mobile application interface for password reset. At the top, there is a back arrow and the title "Password Reset". Below the title is a large blue circular icon with a lock and a checkmark. The form contains three input fields: "Original Password", "New Password", and "New Password" (for confirmation). A blue "Confirm" button is at the bottom. Below the form, three error messages are shown in black rounded rectangles with red numbers 1, 2, and 3 above them:</p> <ul style="list-style-type: none">1. The original password is incorrect2. The two passwords are inconsistent3. The original and new passwords cannot be the same
----	--	---



Charge Mode

Charging Mode:



Click the Charge Mode button to configure the charging mode of the charger, including authentication-free charging and electronic lock fault shield function.

Authentication-free charging function can only be used in offline mode, and the vehicle will be charged immediately after the charging plug is inserted. If after the charger is switched to online mode, authentication-free charging will be prohibited.

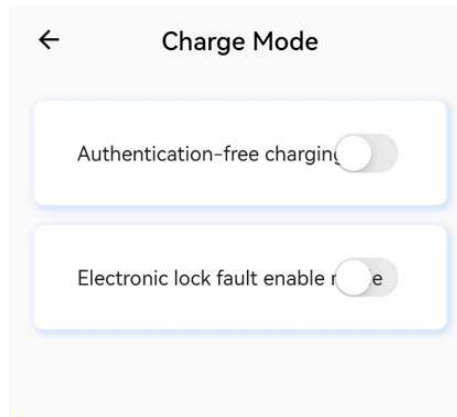
The electronic lock failure shield function is: when the charger reports the electronic lock failure, it needs to continue charging. Users can select the electronic lock failure shield function, which will be executed after the charging plug is inserted/pulled out.



20

21	<p style="text-align: center;"> OCPP</p> <p>OCPP settings: Click the OCPP button to configure the OCPP server address and CPID for the charger. The server address must be used to log in the OCPP server under online mode for the charger.</p>	 <p>The screenshot shows the OCPP settings interface. At the top left is a back arrow, and at the top right is the title 'OCPP'. Below the title, there are two input fields: 'OCPP server address' with the placeholder text 'ws://' and 'Charging pile identification code'. At the bottom of the screen is a blue button labeled 'Settings'.</p>
----	---	--



Load Balancing

Load balancing configuration:

Click the Load Balancing button, you can select:

1. Whether the load balancing function is enabled;
2. Configure the phase position of single-phase charger in power supply system;
3. Configure the master-slave mode of the charger;
4. Configure the charging mode;
5. Configure the charger networking mode (WiFi and Ethernet);
6. Configure the usable grid current under ECO+mode, and the setting range is 0-5A;
7. Selection of master charger electricity meter or CT, and configuration of electricity meter or CT address;
8. Maximum incoming current;
9. Three phase current balance.

22

← Load Balancing



- 1 Load Balancing Enable
- 2 Phase Not Set >
- 3 Master
- 4 Charging Mode ECO+ >
- 5 Network Configuration Ethernet >
- 6 ECO+ Max Current 0-5
- 7 Grid Side Meter Not Set >
- 8 Grid Side Fuse Blowing Current
- 9 Three-phase current balance

Confirm

23

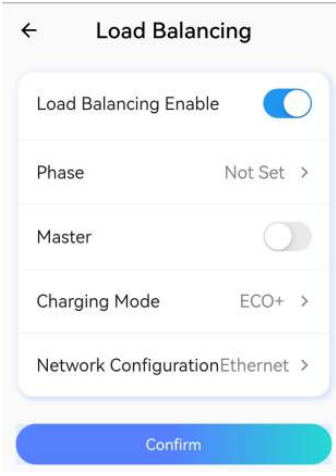
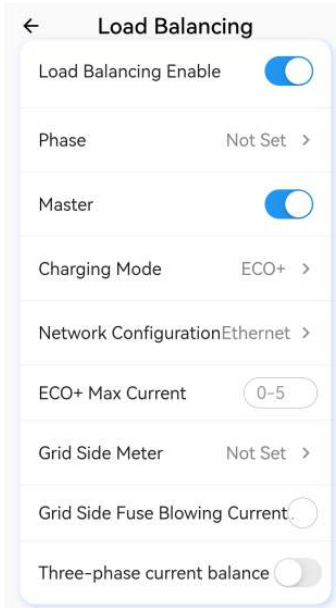
In the Load balancing Setting, the interface of main charger is shown in the upper figure in the right, and the interface of the slave charger is shown in the lower figure.

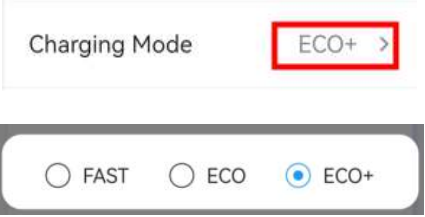
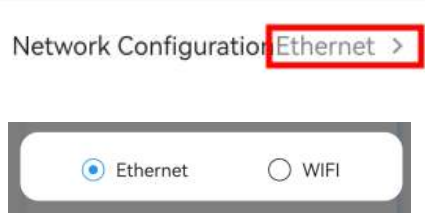

24	<p>In the Load Balancing Setting, for the charging mode configuration, click the red column in the right picture to select "Fast", "ECO" and "ECO +" modes.</p>	
25	<p>In the Load Balancing Setting, the charger networking mode can be configured. Click the red column in the right picture to conduct the load balancing network configuration, and you can select WiFi or Ethernet.</p>	
26	<p>In the Load Balancing Setting, click the red column in the right picture, you can make the selection: connect the main charger to the electricity meter or CT through RS485, and configure the address of the electricity meter or CT, and the address of the electricity meter is 2 by default.</p>	

8.5.2. Administrator operation interface

Steps	Description	Picture
1	<p>Enter the administrator interface:</p> <p>In the Charger Setting, some items can only be used under the administrator mode. After clicking the charger icon in the setting interface for 5 times (red column in the right figure), enter into the administrator interface, and the default password is 123456. After inputting the correct administrator password, you can enter administrator mode and can read and configure the items which require administrator permission.</p>	

2

Administrator interface
Administrator configuration items include common items (they have been introduced in the part of user operation interface) and fault record reading, RFID card configuration, remote upgrade, device type configuration, administrator password modification.

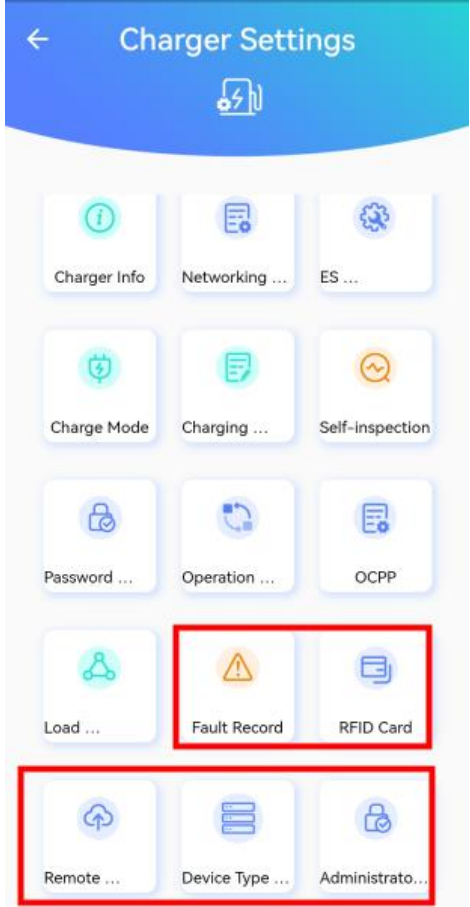

<p>3</p>	<div data-bbox="258 161 311 212" data-label="Image"> </div> <p data-bbox="222 253 349 279">Fault Record</p> <p data-bbox="196 311 521 751">View the charging fault records: Under the administrator mode, click the Fault Record button to view the fault record of the current charger. Similar to the charging record, you can view the fault record according to the quantity and total number of fault records stored in the current charger, and click the Export button in the lower right corner to export the fault record file in Excel format.</p>	<div data-bbox="555 188 580 213" data-label="Image"> </div> <p data-bbox="678 189 818 215">Fault Record</p> <p data-bbox="721 217 776 236">total: 1</p> <div data-bbox="555 276 941 427" data-label="Complex-Block"> <div data-bbox="589 301 642 322" data-label="Text"> <p>▲No.1</p> </div> <table border="1" data-bbox="589 344 910 405"> <tr> <td>Fault Start Time</td> <td>2022-04-06 14:26:12</td> </tr> <tr> <td>Fault End Time</td> <td></td> </tr> <tr> <td>Fault Description</td> <td>CP voltage abnormal</td> </tr> </table> </div> <div data-bbox="714 432 785 459" data-label="Image"> </div> <div data-bbox="826 935 938 1038" data-label="Image"> </div> <p data-bbox="540 1034 549 1054">L</p>	Fault Start Time	2022-04-06 14:26:12	Fault End Time		Fault Description	CP voltage abnormal
Fault Start Time	2022-04-06 14:26:12							
Fault End Time								
Fault Description	CP voltage abnormal							







RFID Card

RFID card configuration:

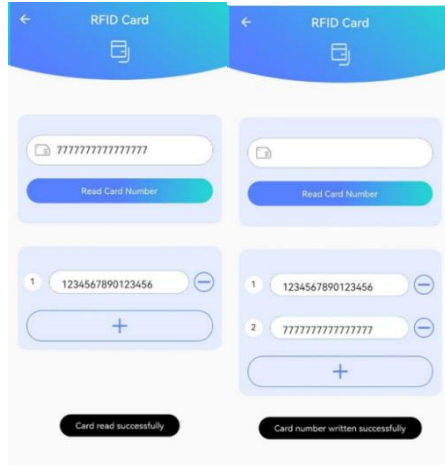
Under administrator mode, click the RFID Card button, and the APP can read the white list of card numbers stored in the current charger; the card number of the physical charging card can also be read; after clicking the Read Card Number button, the RFID card shall be clung to the card swiping area (AREA1) of the charger, and the card number of the current charging card can be read, and it can be copied and written into the white list of the card number of the charger; if the card number is less than 16 digits, it will prompt that the card number is incomplete and cannot be recorded; The numbers of up to 40 charging cards can be stored in the charger.

4

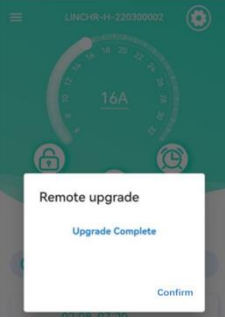
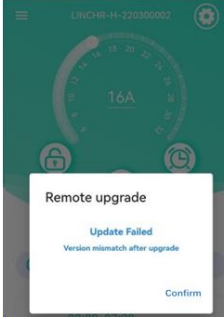

<p>5</p>	<div style="text-align: center;">  <p>Remote Upgrade</p> </div> <p>Remote upgrade:</p> <p>Under administrator mode, copy the upgrade link to the input column, click the Remote Upgrade button, and the APP can remotely upgrade the charger software.</p> <p>First, connect the charger to the network (if Ethernet or 4G cannot be used, you can turn on the hotspot of the mobile phone and provide it for the charger), and then send the "URL" of the upgrade pack to the charger (FTP/HTTP/HTTPS are temporarily supported). After the upgrade package is downloaded, it will prompt that the upgrade request is successful and it starts the upgrade; if the download fails or the URL is incorrect, it will prompt that the request failed. After the upgrade and restarting of the charger is completed, the upgrade result will be fed back according to the result.</p>	   
----------	--	---



Device Type Settings

Configuration of equipment type:

Under administrator mode, click the Device Type Settings button to set the equipment type of the charger.

The charger power can be configured to 7KW (single phase) and 11KW/22KW (three phases).

For connection mode, you can choose CASE B (charging socket version)

6 and CASE C (charging cable version);

Abnormal range of CP: 0.8 V and 1.0 V; electronic lock authentication enabling (under the case B connection mode);

Open state: in the standby state or the charging finishes, the charging plug and the charger continue to be locked, and the charging plug cannot be pulled out from the charger;

Close state, the electronic lock is automatically unlocked after charging finishes, and the charging plug can be pulled out from the charger.

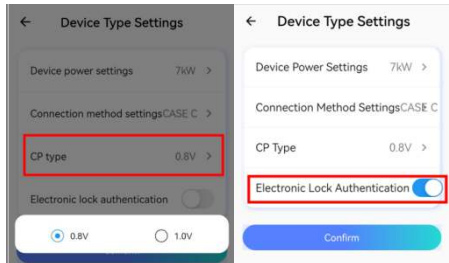
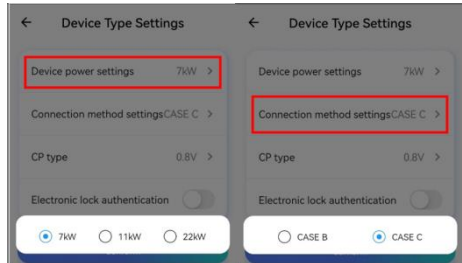

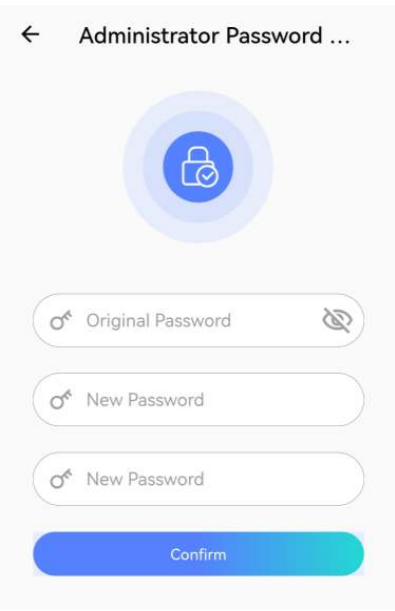
7	<p style="text-align: center;"></p> <p style="text-align: center;">Administrator Password Reset</p> <p>Administrator password modification:</p> <p>Under the administrator mode, click the Administrator Password Reset button to change the administrator password;</p> <p>Similar to the modification of the user password, the previous administrator password (default is 123456) and the new administrator password shall be input, and they shall not be same.</p>	 <p>The image shows a mobile application screen titled "Administrator Password ...". At the top left is a back arrow. Below the title is a large blue circular icon with a white padlock and a checkmark. There are three input fields, each with a key icon on the left and a toggle icon on the right. The first field is labeled "Original Password". The second and third fields are both labeled "New Password". At the bottom is a blue "Confirm" button.</p>
---	---	--

9. OCPP Connection

The charger is connected to OCPP server, which provides a network-based management solution for the charging session.

Through OCPP software platform(back office), the charging session of the charger can be remotely controlled and order management can be carried out (such as charging authorization, report, etc.) .

The charger only supports OCPP1.6J protocol.

9.1 Connection steps of OCPP

9.1.1 Connect the APP, in the setting interface, open the Operation Mode Setting, and set the operation mode to "OPEN" status, as shown in the following figure;

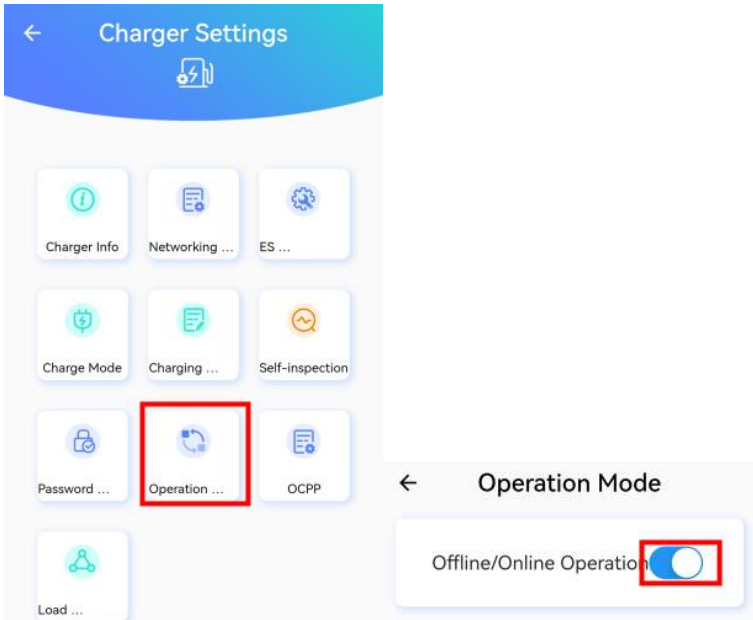

9.1.2 In the setting interface, open OCPP settings, to set OCPP server address and CPID, as shown in the following figure.

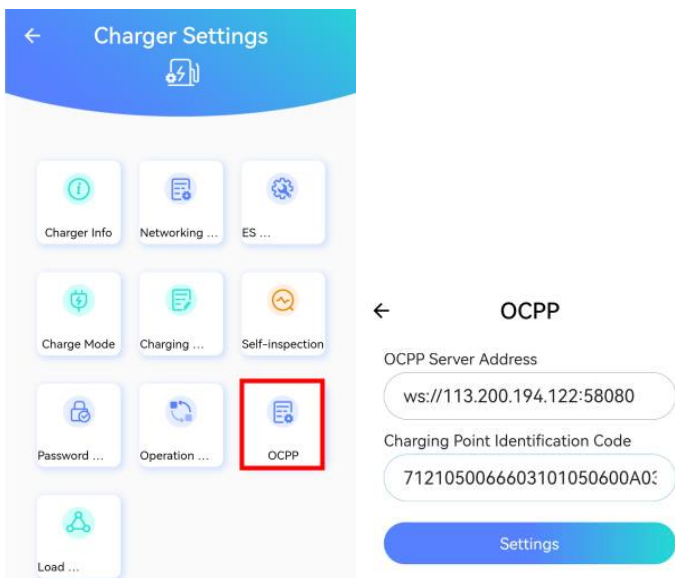

The OCPP server address format is as follows:

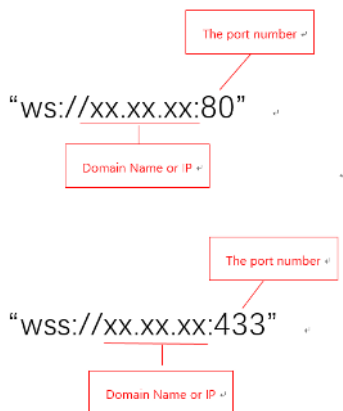

The example is as follows:

OCPP server address: ws://13.200.14.12:58080

CPID: 7121050066603101050600A03

For example, CPID is the SN (serial number) of charging equipment, it is for reference only.

Different platforms have different CPID values. When connecting specific platforms, you shall obtain the corresponding CPID value from the platform.

9.1.3 Ensure that the charger can connect network.

9.2 OCPP1.6J supports the following functions:

Operations Initiated by Central System				
SN	ITEM	realized	restrictions	
1	Cancel Reservation	☑		
2	Change Availability	☑		
3	Change Configuration	☑	☑	Refer to Limit Configuration Key List
4	Clear Cache	☒		
5	Clear Charging Profile	☑		
6	Data Transfer	☑	☑	Agreements need to be made with specific OCPP Server
7	Get Composite Schedule	☑	☑	Retrun 24 hours Schedule
8	Get Configuration	☑		
9	Get Diagnostics	☑	☑	Agreements need to be made with specific OCPP Server
10	Get Local List Version	☑		
11	Remote Start Transaction	☑		
12	Remote Stop Transaction	☑		
13	Reserve Now	☑		
14	Reset	☑		
15	Send Local List	☑		
16	Set Charging Profile	☑	☑	Not support recurrencyKind with Weekly
17	Trigger Message	☑		
18	Unlock Connector	☑		
19	Update Firmware	☑		

Operations Initiated by Charge Point				
SN	ITEM	realized	restrictions	note
1	Authorize	☑		
2	Boot Notification	☑		
3	Data Transfer	☑	☑	Agreements need to be made with specific OCPP Server
4	Diagnostics Status Notification	☑		
5	Firmware Status Notification	☑		
6	Heartbeat	☑		
7	Meter Values	☑	☑	Energy.Active.Import.Register, Current.Import, Voltage
8	Start Transaction	☑		
9	Status Notification	☑		
10	Stop Transaction	☑		

Limit Configuration Key List		
SN	Key	Default Value
1	StopTransactionOnEVSideDisconnect	TRUE
2	AuthorizationCacheEnabled	FALSE
3	ConnectionTimeOut	0
4	MinimumStatusDuration	0
5	BlinkRepeat	0
6	LightIntensity	100
7	MaxEnergyOnInvalidId	0
8	ResetRetries	1
9	MeterValuesSampledData	Voltage, Current.Import, Energy.Active.Import.Register
10	MeterValuesAlignedData	Voltage, Current.Import, Energy.Active.Import.Register
11	StopTxnAlignedData	Energy.Active.Import.Register
12	StopTxnSampledData	Energy.Active.Import.Register
13	ConnectorPhaseRotation	Unknown

10. Charging Operation

Before the charging starts, it is necessary to ensure that the charger's plug is reliably connected with the electric vehicle.

In CASE B charging mode (the charger has charging socket), connect one end of the double-headed European Standard charging cable to the charger and the other end to the electric vehicle.

In CASE C electric mode (the charger has charging cable), connect the charging cable of the charger to electric vehicle.



Warning: In CASE B charging mode (the charger has charging socket), the charging socket is equipped with electronic lock, and the charging plug connected to the charger is automatically locked by the electronic lock during charging. At this time, please do not pull out the charging plug forcedly.

10.1 Start/stop charging through APP

Please refer to 8.5 for APP connection and interface introduction.

You can start or stop charging directly through the "Start and Stop" button (red column below) of the user's main interface on APP!



Start charging



Stop charging

10.2 Start/stop charging through RFID card

When the charger is reliably connected to the electric vehicle, place the RFID in the card swiping area of the charger (AREA1), and it shall be close to the card swiping area as far as possible. When the buzzer generates the "beep" sound, the LED lamp of the charger changes from the "blue lamp always on" to the "blue lamp flashing", and the charger starts charging the electric vehicle.

If you need to stop charging, please place RFID close to the card swiping area again (as close as possible to the card swiping area), and the buzzer generates the "beep" sound, and the charging session is finished. At this time, you can unplug the charger.



Warning: When swiping the card to start charging, if the buzzer generates the "beep" sound twice (the interval is about 0.5s), it means that the RFID card is not authorized!

10.3 Start/stop charging through platform

The platform starts and stops the charging according to OCPP1.6J standard flows. Before the platform issues the starting command, please ensure that the car is reliably connected to the charger.

10.4 Schedule charging

"Schedule charging" can be set in the mobile APP. When the scheduled charging time starts, the charger automatically starts charging, and the charging current is the maximum current under load balancing adjustment. The red column time period in the following figure is the scheduled charging time period.

 Idle State >

 00:00-02:00
Boost Timer

 04-22 ~05-21
Charging Statistics

11. Power management (with external smart meter or CT)

The charger can be connected to the electricity meter or CT through an external port (RS485) to reasonably distribute the power energy.

The charger has an external port, which can be connected to an external smart electricity meter (optional).

The charger can identify the available power of the grid power supply, this means that the charger can adjust the charging power in real time according to the remaining power of other loads (load balancing, see Chapter 12).

Example for description (single phase):

If the power provided by the power grid is 3.7 kW, the charger can conduct charging with the charging power of 3.7 kW (current 16A). At this time, if other loads in the same power grid use 2kW power, the charger automatically adjusts the charging power according to the power management strategy, and the charging power that the charger can use is $3.7-2=1.7$ (kW). At this time, the charger charges the electric vehicle with the power of 1.7 kW.

Note: Under the same power grid, the electricity consumption authority of household load is higher than that of the charger.

12. Load Balancing

12.1 Brief introduction to the function.

12.1.1 Protect the safety of household electricity use and prevent excessive charging power from causing protection of household front air switch and power failure;

12.1.2 Detect three-phases imbalance to prevent excessive load of power grid due to too large power of one phase;

12.1.3 Household electricity use has priority.

12.2 Wiring

12.2.1 Tools

Screwdriver: Electric or manual (straight screwdriver and Phillips screwdriver);

Multimeter;

Cable stripper.

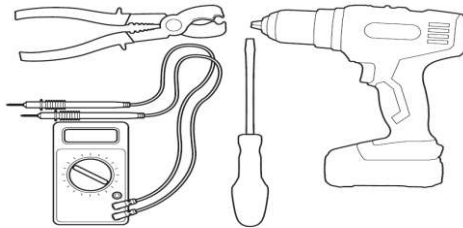

12.2.2 Connecting the devices

The charger;

Smart meter or current transformer (CT);

Note: Due to the particularity, the CT or electricity meter used must be provided by manufacturer!

Router;

Network cable.



12.2.3 Smart meter signal wiring

Three-phase smart meter signal wiring: Three-phase smart meter and the charger are connected by RS485 communication lines, and RS485 signal wiring of three-phase smart meter is shown in the following figure:

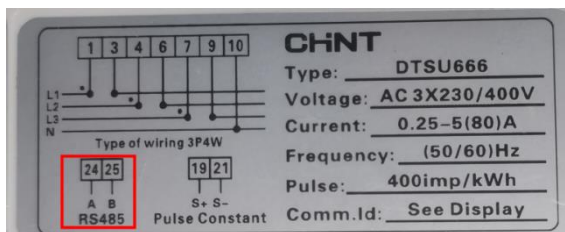

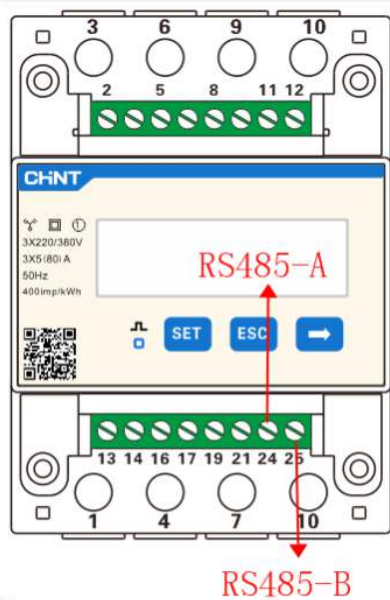

The smart meter signal port "24" is RS485 signal A ;

The smart meter signal port "25" is RS485 signal B.

Single-phase smart meter signal wiring: Single-phase meter and the charger are connected by RS485 communication lines, and RS485 signal wiring of single-phase meter is shown in the following figure:

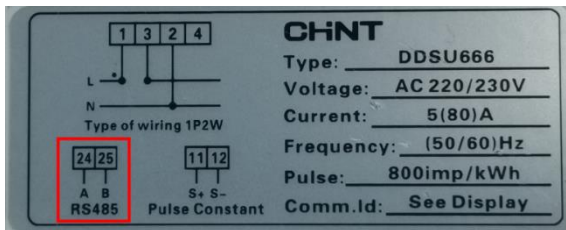

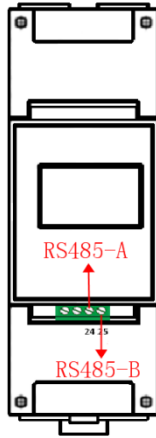

The smart meter signal port "24" is RS485 signal A;

The smart meter signal port "25" is RS485 signal B.

12.2.4 The current transformer clamp signal wiring is shown in the following figure:

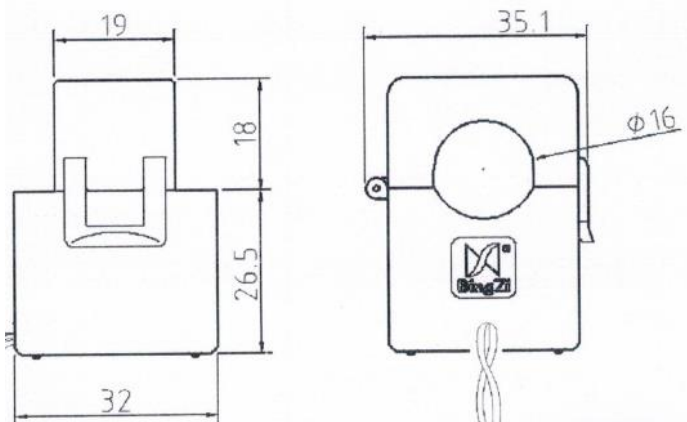

12.2.5 The charger signal wiring

The charger and smart meter signal wiring: the charger and smart meter are connected by RS485 communication cable, and the charger RS485 signal wiring is shown in the following figure:

The charger signal port "9" is RS485 signal A;

The charger signal port "10" is RS485 signal B.

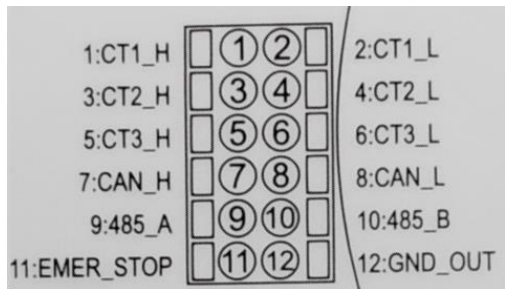
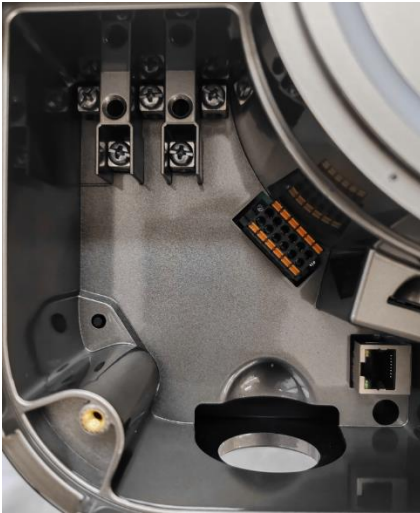

The wiring between the smart meter and the charger is as follows:

The charger signal port "9" (RS485 signal A) is connected with the electricity meter signal port "24" (RS485 signal A);

The charger signal port "10" (RS485 signal B) is connected with the electricity meter signal port "25" (RS485 signal B);

The wiring between current transformer(CT) and the charger is as follows:

Single phase:

CT White to 1 (CT1_H) , CT Black to 2 (CT1_L) ;

Three phase :

CT 1 White to 1 (CT1_H) , CT 1 Black to 2 (CT1_L) ;

CT 2 White to 3 (CT2_H) , CT 2 Black to 4 (CT2_L) ;

CT 3 White to 5 (CT3_H) , CT 3 Black to 6 (CT3_L) .

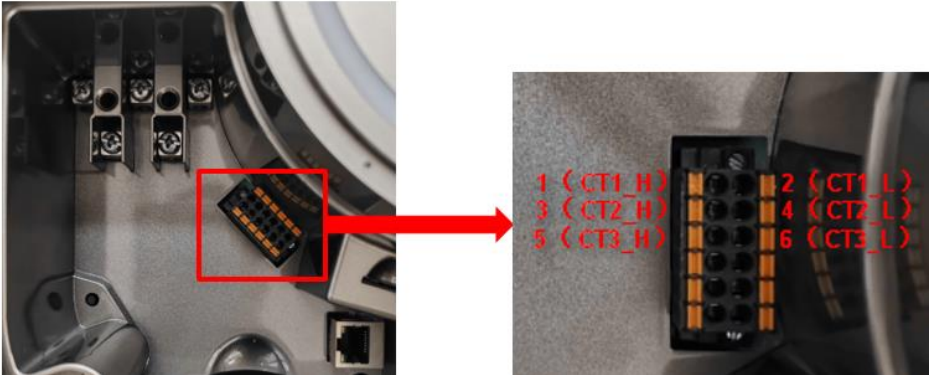

If the grid system is single-phase, it can be connected with single-phase electricity meter or one current transformer.

If the grid system is three-phase, it can be connected with smart electricity meter or three current transformers.

12.3 Load Balancing Configuration

Connect APP, enter administrator mode, open "Load Balancing", select Load Balancing Enable, and set phase, the master and solar working mode. Make sure that the settings are consistent with the actual connection, otherwise the load balancing may not work normally.

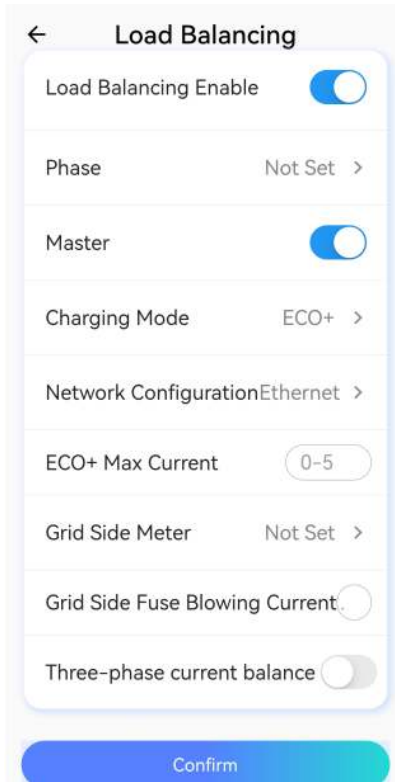

Description of load balancing configuration

Master:

Enable the master, set the master/slave mode of the charger. The charger connected with smart meter is the master, and the charger which is not connected with smart meter is the slave. Configure information of the master as shown in the following figure, and configure the following information according to the actual master/slave situation of the charger.

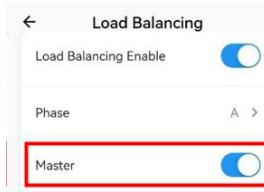

Phases:

Configure the phases of the power grid system where the single-phase charger is located. If it is connected to Phase A of the power grid, configure this parameter as A.

Solar working mode:

According to the actual usage scenario, configure the charging mode, three charging modes can be configured: FAST, ECO and ECO + mode.

FAST: Quickly charge with the maximum charging power without exceeding the maximum current set by the user.

ECO mode: It is a continuous charging mode. When solar energy is sufficient, consume the solar energy as much as possible, and when solar energy is insufficient, it charges the vehicle according to the minimum charging current.

ECO + mode: Green and economic mode. When solar energy is sufficient, consume solar energy as much as possible, and when solar energy is insufficient, the allowed maximum consumption of non-solar current is a fixed value, when the consumption exceeds the value, charging is suspended.

ECO +current: under ECO+ mode, maximum non-solar current allowed for consumption.

Network settings: Configure the network parameters of load balancing, including WiFi and Ethernet (two chargers are connected through WiFi or Ethernet);

Ethernet: Users can choose fixed IP or dynamically allocate IP addresses;

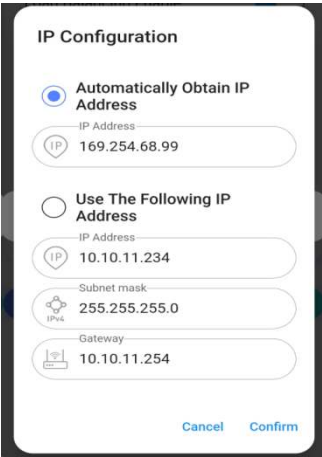

WiFi: Input the correct WiFi name and WiFi password;



Note: Ensure that the device load balancing network configuration is the same for all devices, otherwise communication may fail and the load balancing function will not work normally.

Power grid side smart meter: Configure the address of power grid side smart meter (address is in red column), and the address of electricity meter is 2 by default.

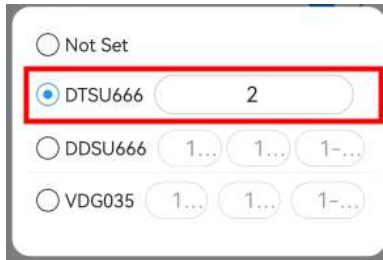

Power grid side CT: select the VDG035

For single phase: Selection and input 2 (other number is also okay) for Corresponding phase.

Phase A or B or C Corresponding input the number;



For three phase: Selection and input different number (other number is also okay) for Corresponding phase;



Maximum current that can be set by user: the maximum allowable current of the current system

Three-phase current imbalance: After opening, adjust the three phase currents to make them balance when conditions permit, make the imbalance rate is less than 15%.

12.4 Networking of Chargers

12.4.1 2 Chargers Networking (Ethernet connection)

When conduct networking of 2 chargers using Ethernet cables, you need to turn on the load balancing function on APP for both of them, Set the master charger and slave charger modes (1 master and 1 slave), and in the load balancing interface, set the "Networking Configuration " as Ethernet. Two chargers need to be set with different IP addresses in the same network segment, and then connect the two chargers directly with a network cable, and wait for 3min. If the APP interface does not prompt the networking failure, it means that networking of the 2 chargers is successfully.

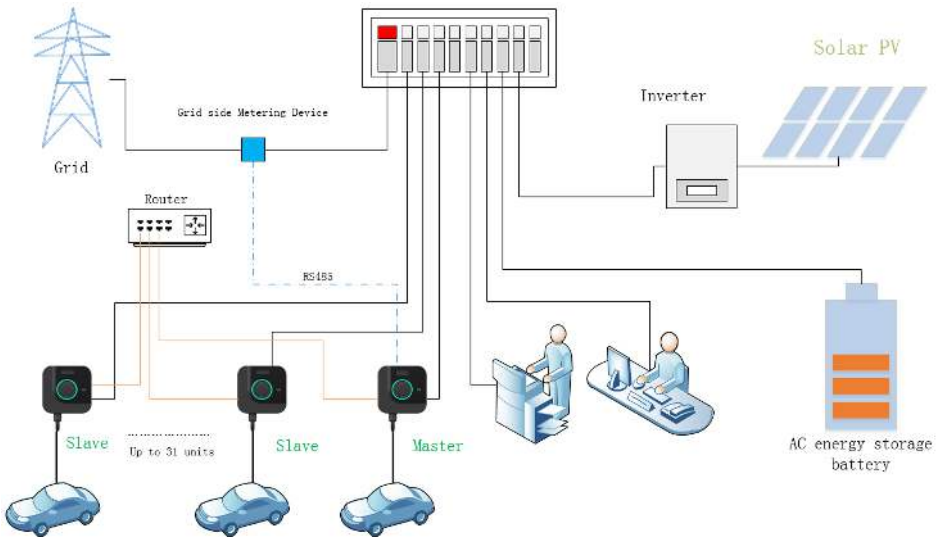

12.4.2 2 chargers Networking (WiFi connection)

When conduct networking of 2 chargers through WiFi (routers must be equipped), turn on the load balancing function on the APP for both of them, set the master charger and slave charger modes (1 master and 1 slave), and in the load balancing interface, set the "Networking Configuration" as WiFi. In the APP load balancing interface, input the same WiFi name and WiFi password for the 2 chargers, and wait for 3min. If the APP interface does not prompt the networking failure, it means that networking of the 2 chargers is successfully.

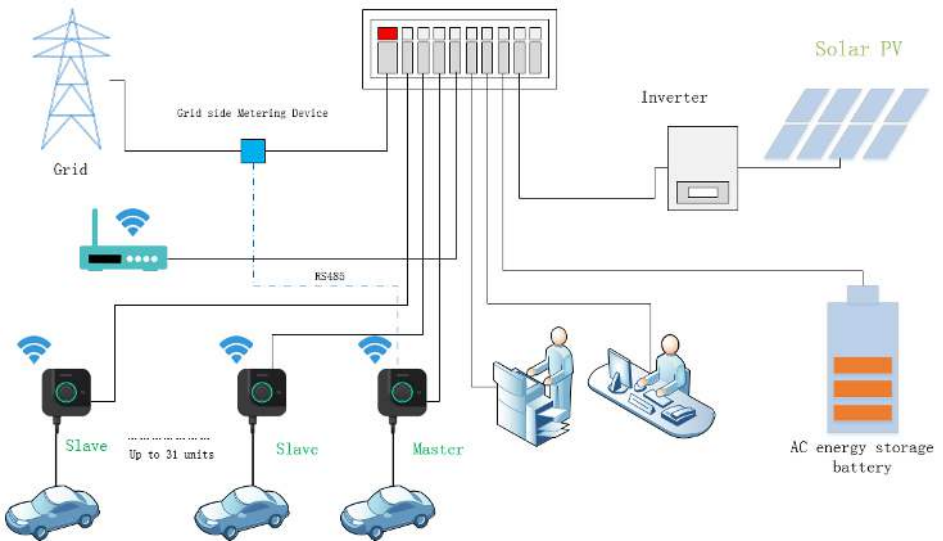

12.4.3 Multiple chargers Networking

When conduct networking of multiple chargers through WiFi or using network cable (router must be equipped, and in case of networking with network cable, it can also be equipped with switchboard). Turn on the load balancing function on APP for all of the chargers, set master charger and slave charger modes (1 master and multiple slaves), and in the load balancing interface, set "Networking Configuration", both of WiFi or Ethernet are allowed. When setting WiFi, WiFi name and WiFi password must be the same. When setting Ethernet, ensure that in the same network segment, there are different IP addresses, and wait for 3min. If the APP interface does not prompt networking failure, it means that networking of the chargers is successfully.

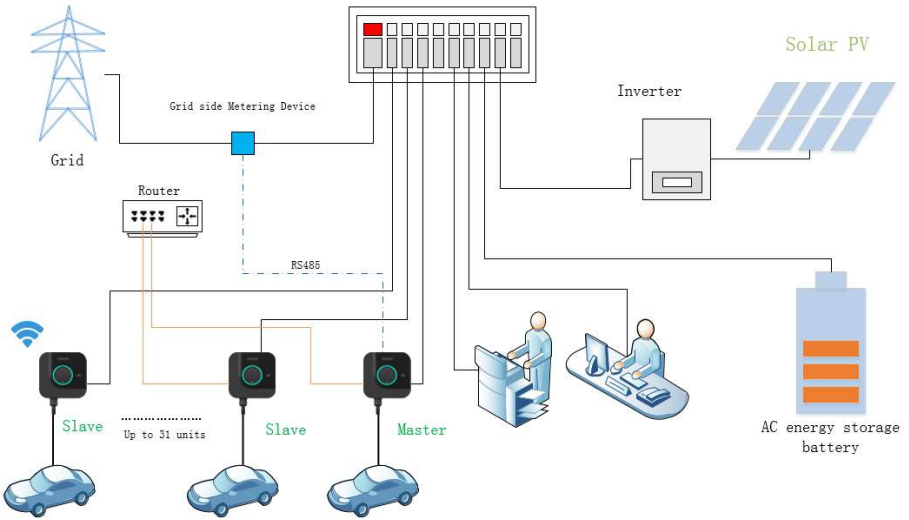

In the above systems, smart meter can also be replaced by CT !

13. Upgrade of the system

13.1 Local APP upgrade

13.1.1 Connect the charger to the network through Ethernet (WiFi or 4G), open the mobile APP, and under the administrator mode, enter the remote upgrade interface, as shown in the following figure:

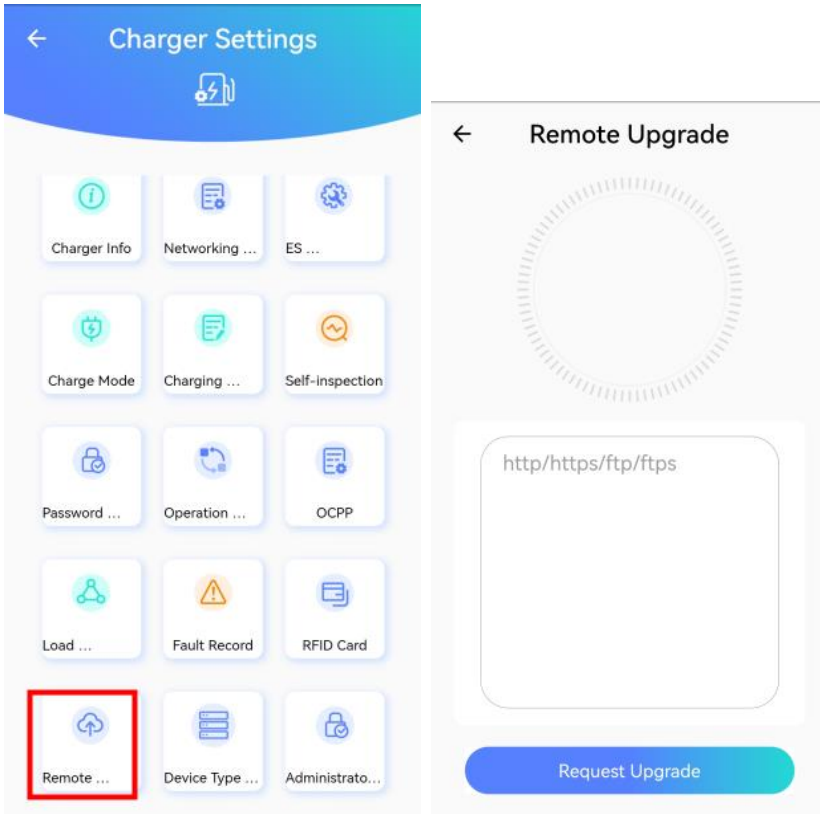

13.1.2 Copy the "URL" link of the upgrade pack to the upgrade column, for example, copy the following upgrade link to the upgrade column:

<ftp://10.0.10.149/updateA7.tar.gz|XATGOOD/JLCPCS2|123456|6d46c881b347c212deb3c28686d4a7ad>

The interface is as follows (the red column is the upgrade column);



13.1.3 Click "Request Upgrade" to request the upgrade, and after the request is completed, click "Start Upgrade", it will start the upgrade, as shown in the figure below:

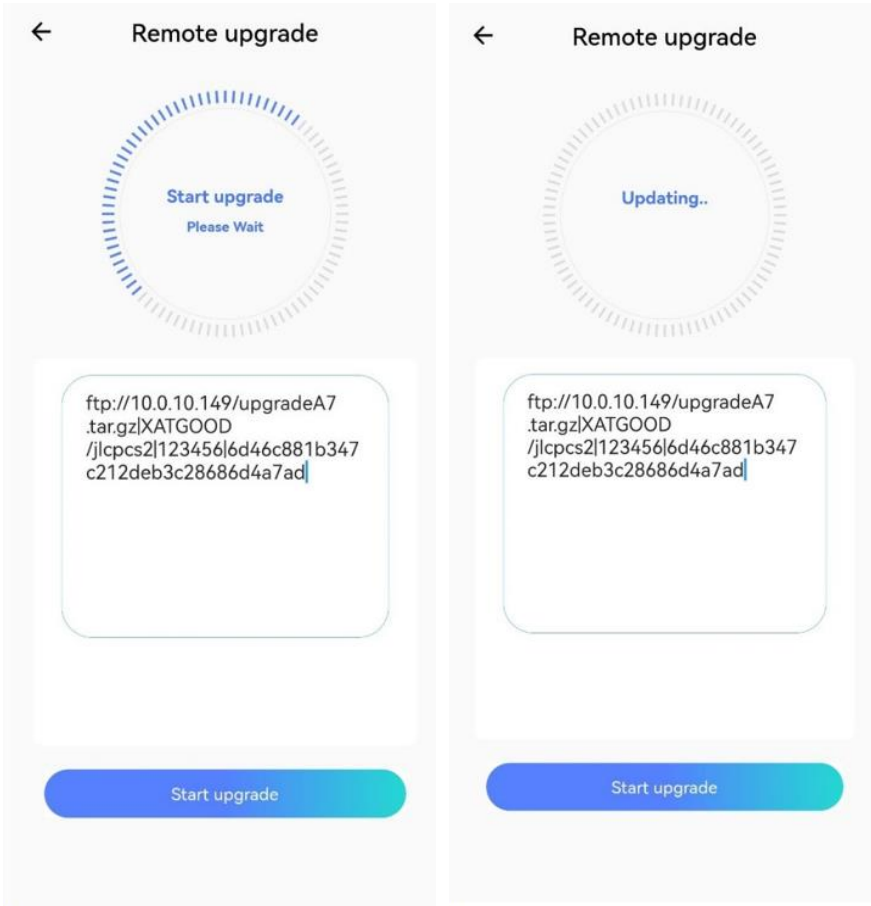

13.1.4 The interface of successful or failed upgrade is shown in the figure below:

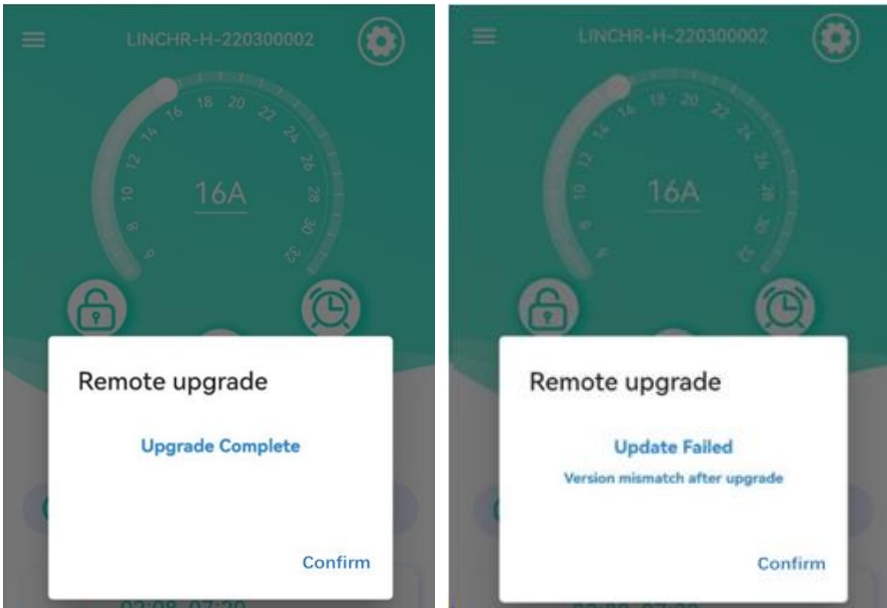

Open the mobile APP and enter the remote upgrade interface under administrator mode, as shown in the following figure:

Then send the "URL" of the upgrade pack to the charger (FTP/HTTP/HTTPS are temporarily supported). After the download of the upgrade pack is completed, it will prompted that the upgrade request is successful and it starts the upgrade; if the download fails or the URL is wrong, it will prompted that the request failed. After the charger upgrade is completed and restarted, the upgrade result will be fed back.

13.2 Remote OCPP upgrade

13.2.1 Connect the charger to OCPP platform through Ethernet (WiFi or 4G);

13.2.2 Send the "URL" of the upgrade pack to the OCPP platform, and OCPP will issue the upgrade pack to the charger, the upgrade is completed.

14, SIM Card Configuration

14.1 SIM Card Installation

When using 4G/5G networking, you need to install a SIM card on the charger.

The schematic diagram as follows:

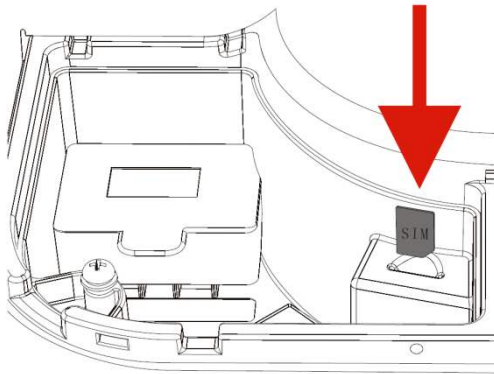

After the SIM card is installed in place, open the manufacture APP, select 4G/5G in the APP network configuration interface, and configure the SIM card APN information, as shown in the following figure:

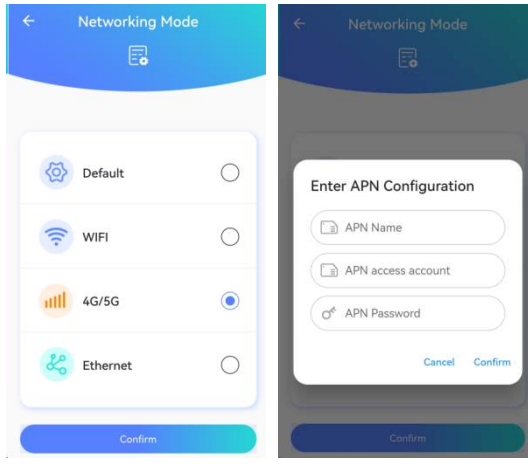

14.2 SIM card removal

When not using the 4G/5G networking, open the charger maintenance bin and take the SIM card out. When taking out the SIM card, press the SIM card first, and then take out the SIM card after it pops up, as shown in the following figure:

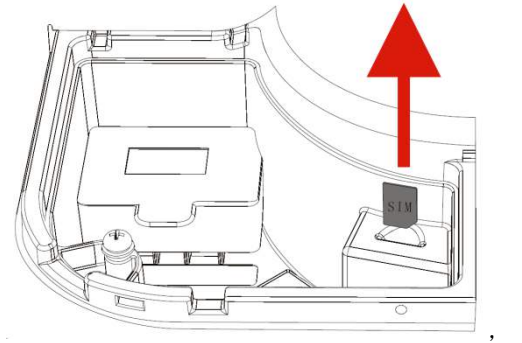

15, Troubleshooting

Fault info	Reason	Solution
Abnormal Grounding Fault	The PE cable is not connected or there is a problem with the system settings.	When the PE cable is not connected, check whether the TT, IT, TN systems settings are set to the expected results. If the settings is successful, check whether the PE cable is connected.
Overvoltage Fault	Single phase: input voltage is detected to be greater than 276VAC±3VAC for 5 seconds; Three phase: input voltage is detected to be greater than 460VAC±3VAC for 5 seconds.	Single phase recovery logic: when the voltage is lower than 254±3VAC, the state of plugging in will be recovered; Three phase recovery logic: when the voltage is lower than 450±3VAC, the state of plugging in will be recovered.
Undervoltage Fault	Single phase: input voltage is lower than 154VAC±3VAC for 5 seconds; Three phase: input voltage is lower than 340VAC±3VAC for 5 seconds.	Single phase recovery logic: if the voltage is higher than 164±3VAC, the state of plugging in will be recovered; Three phase recovery logic: if the voltage is higher than 350±3VAC, the state of plugging in will be recovered.
Metering Communication Failure Fault	The communication between the master charger and the grid-side smart metering device fails	Check whether the communication address settings of the smart metering device in the APP are consistent with the communication address of the external smart metering device. If they are inconsistent, set the same in the APP.

Metering Failure Fault	Metering module chip reading incorrectly or metering chip failure.	Restart the charger 3 times in a row to see if the fault eliminated. If it is not eliminated, the metering chip is damaged, return the charger to factory for repair.
CP voltage abnormal Fault	When the charger detects that the CP signal is between -11~2V, it will report a fault.	Re-plug to check whether the CP voltage is normal, if not, return to the factory for repair.
Overcurrent Protection Fault	The charging current is greater than the preset current limit(1.1 times) and remains above 5 seconds.	After plug out, re-plug in to charge, and check whether there is a fault. If it does, it means that the current limit cannot be limited by the vehicle. It is recommended to set the current limit to the maximum(32A).
Relay Overtemperature Fault	The relay temperature is higher than the relay over-temperature protection threshold ($125 \pm 5^{\circ}\text{C}$).	Stop charging and wait for the relay to cool down before charging again.
Input Overtemperature Fault	The temperature of the power input terminal is higher than the over-temperature protection threshold of the power input terminal ($115 \pm 5^{\circ}\text{C}$.)	Check whether the power input wire is in poor contact or the power input wire is aging; Stop charging and wait for the power input terminal to cool down before charging again.

Socket overtemperature Fault	The temperature of the socket is higher than the over temperature protection threshold of the socket ($115 \pm 5^{\circ}\text{C}.$)	Stop charging and wait for the relay to cool down before charging again.
Leakage Protection Fault	It is detected that the AC leakage the $\text{DC} \geq 6\text{mA}$ (RCD is not applicable to TN-C system).	Restart the charger 3 times in a row to see if the fault is eliminated, if not, return it to the factory for repair.
Electronic Lock Protection Failure	After executing the electronic lock action command, it is detected that the state of the electronic lock is still the initial state, and the charger should report the electronic lock failure within 5s	Start or stop charging 3 times in a row to see if the fault is eliminated, if not, return to the factory for repair.
Power Failure Fault	The charger is powered off during the charging process.	Restart the charger to eliminate failure.
Abnormal Charging Circuit Fault	The relay is not closed when the start charging is issued or the relay is suddenly disconnected during the charging process.	Start charging 3 times in a row to check if the fault is eliminated, if not, return to the factory for repair.
LN Reverse Connection Fault	The input L-N line is reversed.	Exchanging the L-N Input Wiring
Phase Failure Fault	Three-phase input port open-phase access or single-phase are set as three-phase.	Check whether the charger type is set correctly in the APP settings. If correct, check whether the input port is missing phase. If not, check whether the three-phase voltage input is normal.

Leakage Fault Of PE Line	PE line leakage current $\geq 30\text{mA}$ or three-phase unbalanced N line voltage $\geq 70\text{V}$ and PE disconnection.	Restart the charger 3 times in a row to see if the fault is eliminated, if not, return it to the factory for repair.
Load Balancing Networking failure	The communication between the slave charger and the master charger failed.	Check whether the IP of the slave charger and master charger are in the same network segment.
Card Reader offline	Card reader does not communicate	Restart the charger 3 times in a row to see if the fault is eliminated, if not, return it to the factory for repair.
Backend Connection Abnormal	Not connected to the platform	Check the network configuration and whether the charging pile is connected to the network normally
Vehicle Leakage Alarm	Electric leakage of vehicle	Recover after unplugging the charging gun and making it normal
Plug Out With Load	Unplug the charging gun during charging	Automatic recovery after 10s

Importer: xxx

Address: xxx

WiFi(Only 2.4G wireless technology is supported):

Frequency: 2412MHz -2472MHz

Output Power: 802.11 b/g/n: <18.5dBm

BLE:

Frequency: 2402-2480MHZ

Output Power: 1.8dBm

RFID:

Frequency: 13.56MHZ

GSM/LTE:

Frequency:

GSM 850/900/1800/1900 MHz

LTE-FDD B1/B3/B5/B7/B8/B20/B28

LTE-TDD B38/B40/B41

Output Power:

GSM850: 33 dBm

EGSM900: 33 dBm

DCS1800: 30 dBm

PCS1900: 30 dBm

LTE-FDD B1/B3/B5/B7/B8/B20/B28: 23 dBm

LTE-TDD B38/B40/B41: 23 dBm

Download Hcharger APP



Company Name:

Hydra EVC Ltd.

Company Address:

Unit 11, Totman Close, RAYLEIGH Essex SS6 7UZ UNITED KINGDOM